

Table of Contents

Merge Collectors

	How to order	4
	Style Options	5
MC	Merge Collector	6
DSMC	Double Slip Merge Collector	7
	Tri-Y Merge Collector	8-9
WMC	Weld-on Merge Collector	10
YC	Y-Collector & X-Pipes	11
FC/SFC	Formed Collector	12-13
CT	Collector Transitions	14-15
	Collector Retainers	16
	Bellows	17

Tubing

ZK	Zoomie Kits	18
	Mandrel Bends	19-21
ST	Straight Tubing	22-23
TE	Tube Extentions	23

CNC Machined Flanges

	Header Flanges	24-35
VBC/SF	V-Band Clamps & Sealing Flanges	36
F	Exhaust Flanges	37-39
TF	Turbo Flanges	40-41

Accessories

ARP	Header Bolt Kits	42
	Weld-on Bungs	43
	T-Bolt Clamps	44
	T-Shirts	44
	Fabrication Supplies	45

Fabrication & Manufacturing

	<i>Vehicle Specification Form</i>	48
	Terms & Conditions	49

Getting Everthing You Can (Out Of It)

The exhaust systems role in increasing engine performance centers around improving volumetric efficiency. Volumetric efficiency refers to the ability of an engine to intake and expel gases (i.e.: air/fuel and exhaust gas), in relation to the actual pumping volume of the engine. Free flowing intake and exhaust systems help an engine to achieve this. Achieving greater than 100% "VE" is done in part by optimizing exhaust gas scavenging to draw out exhaust and bring in air fuel mixture during valve overlap. As the piston reaches the top of the exhaust stroke, it dwells as the crankshaft sweeps across the top of its stroke. This is where valve overlap occurs. Before the piston is at TDC, the intake valve begins to open. The trick is to design the exhaust system so that the exhaust pulse (pressure wave) leaves behind a pressure drop or vacuum to take advantage of the valve overlap. If successful the combustion chamber will exchange residual exhaust gases for a fresh air/fuel mixture before the piston has any real effect on the intake charge.

To design a successful exhaust system or tuned header, the tube size and length are selected based on a list of engine specifications and application characteristics. The tube size controls the speed of the exhaust pulse, too big and the velocity (energy) is lost. The tube length is all about timing the pulse to synchronize with the cam in a specific RPM range.

At the collector, the timing of the pulses is crucial to scavenging. Imagine a four lane freeway on ramp merging into one lane. If you get the timing and speed right, the pulses draft each other like stock cars at Daytona, increasing their speed. This is where the Merge Collector comes in. It makes that transition from primary tube to collector as smooth as possible. This reduction in turbulence helps maintain velocity through the collector, thus increasing the scavenging power of the header system.

If you are not sure of your header and collector design please fill out the **vehicle spec sheet** on page 48 and send it to us.

Merge Collectors

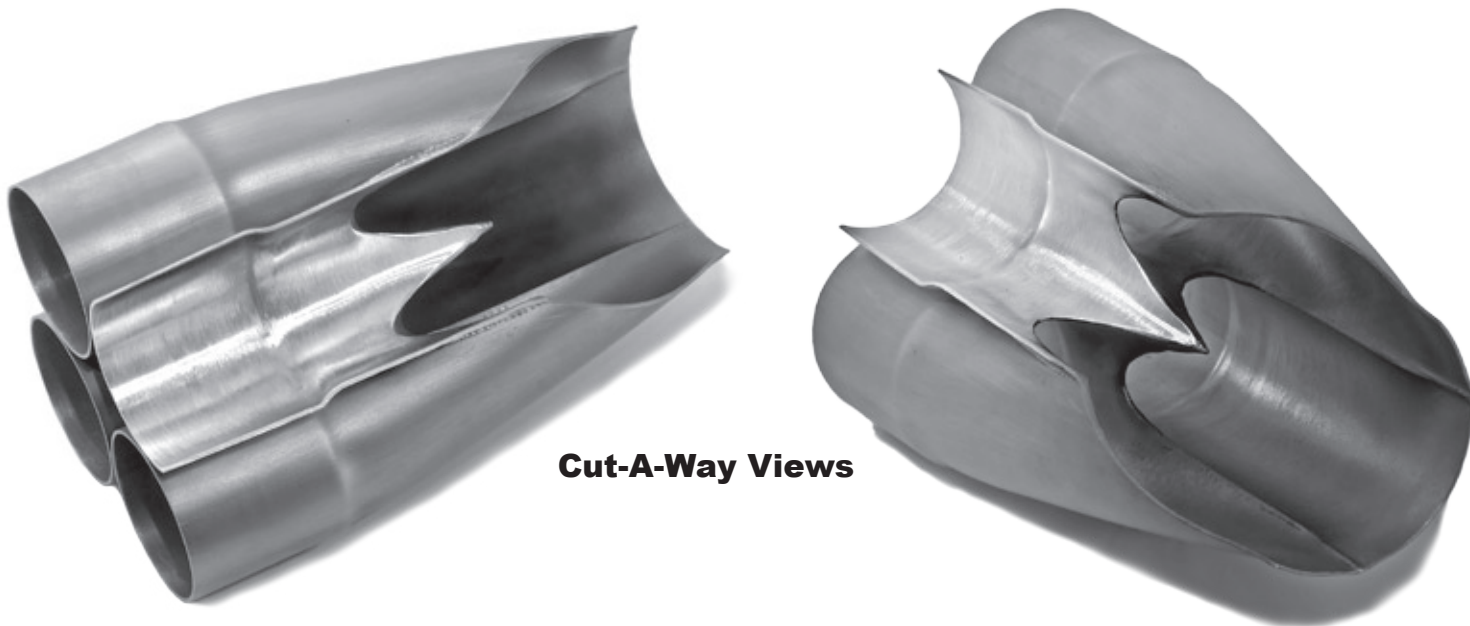

Merge Collectors have been used for many years in F-1 and Indy cars. The technology trickled down into almost all forms of professional racing. Today they have become common place. In competition, merge collectors are used wherever rule books allow.

On pages 3 through 11 you will find information on merge collectors to help you decide what type is for you. If you need more help give us a call or fill out the vehicle spec sheet (pg. 48) and fax / e-mail it to us.

Merge Collectors Configurations

WMC25200-4-30416

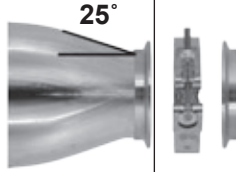

VBK300S
(V-Band Clamp)

MC25200-4-30416

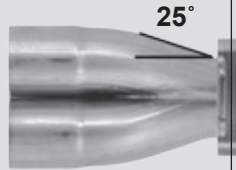

TF041813
(T04 Turbo Flange)

MC20200-4-30416

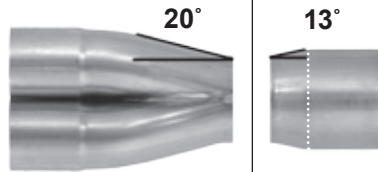

CT300-350S16

MC15200-4-30416

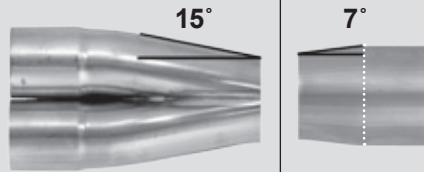

CT3007-350S16

MC12200-4-30416

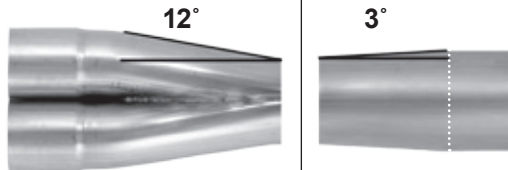

CT3003-350S16

MC12200-4-30416

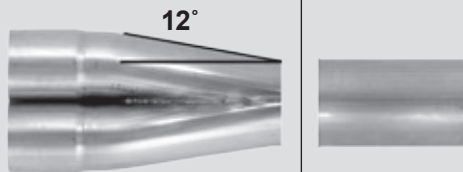

ST300S16
(Straight Tubing)

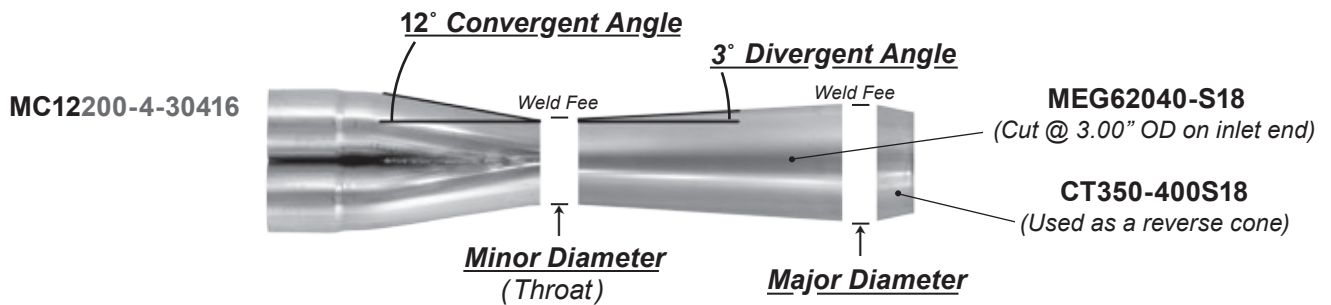

- ▶ 12 & 15 degree convergent angles offer the greatest performance gains.
- ▶ 20 & 25 degree convergent angles are used where space constraints are the primary concern.
- ▶ Call for recommendations on transitions.

Merge Collectors

How To Order

Style Options

MC
DSMC
WMC
FMC
BMC

MC

12

Tube O.D.

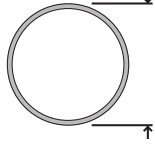

200

Material Type

For stainless steel
use -304 or -321

For mild steel
leave blank

4 - 304

Minor Diameter

(Throat Size)
Specify throat
size when you
place your order

16

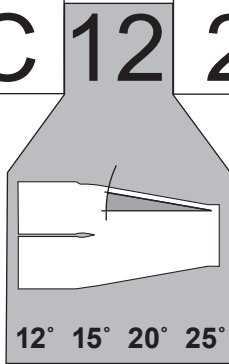

12° 15° 20° 25°

Convergent Angle

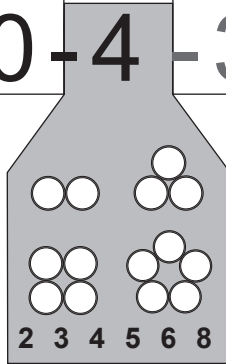

2 3 4 5 6 8

of Tubes

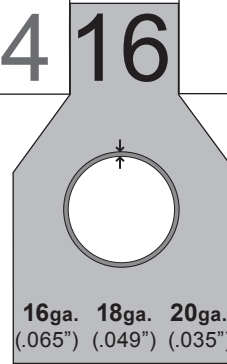

16ga. 18ga. 20ga.
(.065") (.049") (.035")

Gauge

(Wall Thickness)

Merge Inlet Tube Size	2 into 1	3 into 1	4 into 1	5 into 1	6 into 1	8 into 1
1.250	MCxx125-2	MCxx125-3	MCxx125-4	S/O	S/O	S/O
1.375	MCxx138-2	MCxx138-3	MCxx138-4	S/O	S/O	S/O
1.500	MCxx150-2	MCxx150-3	MCxx150-4	MCxx150-5	MCxx150-6	MCxx150-8
1.625	MCxx163-2	MCxx163-3	MCxx163-4	MCxx163-5	MCxx163-6	MCxx163-8
1.750	MCxx175-2	MCxx175-3	MCxx175-4	MCxx175-5	MCxx175-6	MCxx175-8
1.875	MCxx188-2	MCxx188-3	MCxx188-4	MCxx188-5	MCxx188-6	MCxx188-8
2.000	MCxx200-2	MCxx200-3	MCxx200-4	MCxx200-5	MCxx200-6	MCxx200-8
2.125	MCxx213-2	MCxx213-3	MCxx213-4	MCxx213-5	MCxx213-6	MCxx213-8
2.250	MCxx225-2	MCxx225-3	MCxx225-4	MCxx225-5	MCxx225-6	MCxx225-8
2.375	MCxx238-2	MCxx238-3	MCxx238-4	S/O	S/O	S/O
2.500	MCxx250-2	MCxx250-3	MCxx250-4	S/O	S/O	S/O
2.625	MCxx263-2	S/O	MCxx263-4	S/O	S/O	S/O
2.750	MCxx275-2	S/O	MCxx275-4	S/O	S/O	S/O
3.000	MCxx300-2	S/O	S/O	S/O	S/O	S/O
3.500	MCxx350-2	S/O	S/O	S/O	S/O	S/O

Ordering Options

Part Only



6 way MC

With Transition



4 Way WMC
w/ 7 degree transition

Finished Assembly (flanges, tabs, or bungs)



2 Way DSMC's
w/transitions &
T04 tangential flange

Merge Collectors

Style Options

(MC) Merge Collector

The traditional Merge Collector can be used as a removable piece or welded. Prebent tubes are machine cut and hand fit to form a pyramid inside each collector for proper airflow management.

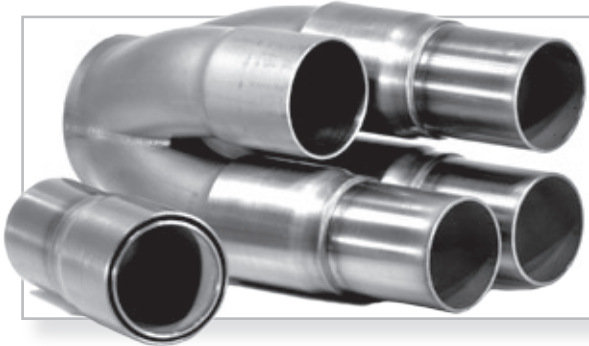

(DSMC) Double Slip Merge Collector

DSMC's are used primarily in turbo applications where the benefits of a true merge are needed and a removable collector offers the best design solution. The double slip receivers provide the extra seal necessary to prevent the loss of exhaust manifold pressure.

(WMC) Weld-on Merge Collector

WMC's are used primarily in turbo applications where space constraints are the biggest concern. The WMC's form is like that of a formed collector but, is constructed like a merge collector to provide the material strength necessary to withstand the stresses of a turbo application. WMC's also allow for the use of a smaller outlet size than is possible with a formed collector.



(FMC) Flat Merge Collector

This FMC style collector allows for maximum ground clearance. Applications include street rods, transverse mounted inline 4 cylinders, and flat opposed 4 or 6 cylinders .

(BMC) Bent Merge Collector

Building a tuned header in a confined space can present some real challenges. The BMC is designed to help solve some of those problems that can arise when building a Tri-Y system. Rather than compromise tube length, this part allows you place the primary or secondary 2 way collector while changing direction.



(MC) Merge Collectors

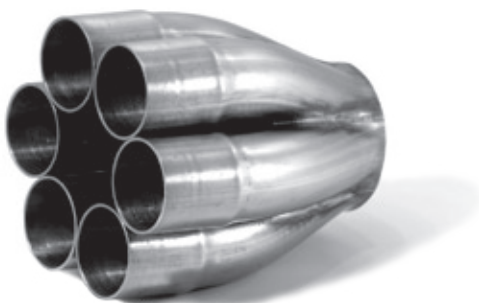
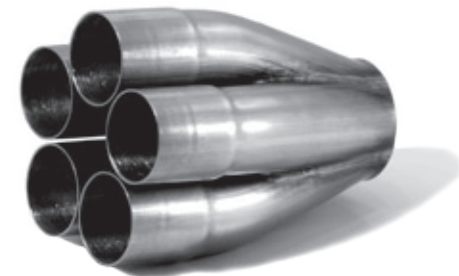

- ▶ Merge Collectors are a common choice of professional engine builders and race teams.
- ▶ Prebent tubes are machine cut and hand fit to form a pyramid inside each collector.
- ▶ Merge Collectors are TIG welded (Purge style) to ensure professional performance and appearance.
- ▶ SPD Merge Collectors are cleaned and polished inside for maximum flow.



Collectors shown w/ transition, straight tubing, wing tabs, and O2 bungs

Available Options

- ▶ 12°, 15°, 20°, 25° convergent angle
- ▶ 1.25" to 3.50" tube size
- ▶ 2 way - 8 way
- ▶ 304, 321, 1008
- ▶ .065", .049", (.035" SST only) wall thickness

See page 2 for part numbering system

When Ordering Specify

- ▶ Throat Size (*Minor Diameter*)
- ▶ Outlet Options
(*Flanges, Transition, Tubing*)
- ▶ Custom Finish Work
(*Tabs, Bungs, Wastegate Tube*)



SPECIALTY
PRODUCTS
DESIGN, INC.

Double Slip Merge Collectors (DSMC)

Double Slip Merge Collectors are used primarily in turbo applications where the benefits of a true merge are required and a removable collector offers the best design solution. The double slip receivers provide the extra seal necessary to prevent the loss of exhaust manifold pressure. The slip connection allows the system to expand and contract under the extreme temperature swings seen in turbo headers, reducing the potential for cracking.

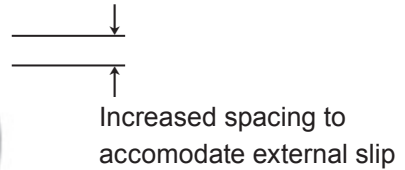

- ▶ External slip tubes are included in the price of the collector.
- ▶ Use collector as a jig when welding external slips to your header tubes



Available Options

- ▶ 12°, 15°, 20°, 25° convergent angle
- ▶ 1.25" to 2.50" (2 ways up to 3.50") tube size
- ▶ 2 way - 8 way
- ▶ 304, 321, 1008
- ▶ .065", .049", (.035" SST only) wall thickness

See page 2 for part numbering system

When Ordering Specify

- ▶ Throat Size (*Minor Diameter*)
- ▶ Outlet Options
(*Flanges, Transition, Tubing*)
- ▶ Custom Finish Work
(*Tabs, Bungs, Wastegate Tube*)

Tri-Y Slip Together



Tri-Y collectors are steadily increasing in popularity and being used in applications where 4 into 1 collectors were previously the only way to go. The attraction is a broader, less "peaky" power band. Most are used in applications with wide RPM swings and part throttle situations, such as street cars, road racing, late model stocks, and off-road racing. The Tri-Y stereotype of only low end torque applications continues to be erased as Tri-Y's break into new arenas like the NHRA and IHRA.

Adjustability is another selling point for the 4-2-1 design. You can change primary or secondary collector sizes, lengths and tube sizes between the Y's or even convert back to 4 into 1 to alter the engines power band. This allows you to keep up with ever changing track and/or weather conditions.

Available Options

- ▶ 12°, 15°, 20°, 25° convergent angle
- ▶ 1.25" and up tube size
- ▶ 304, 321, 1008
- ▶ .065", .049", (.035" SST only) wall thickness

See page 2 for part numbering system

When Ordering Specify

- ▶ Throat Size (*Minor Diameter*)
- ▶ Outlet Options
(*Flanges, Transition, Tubing*)
- ▶ Custom Finish Work
(*Tabs, Bunges, Flanges*)

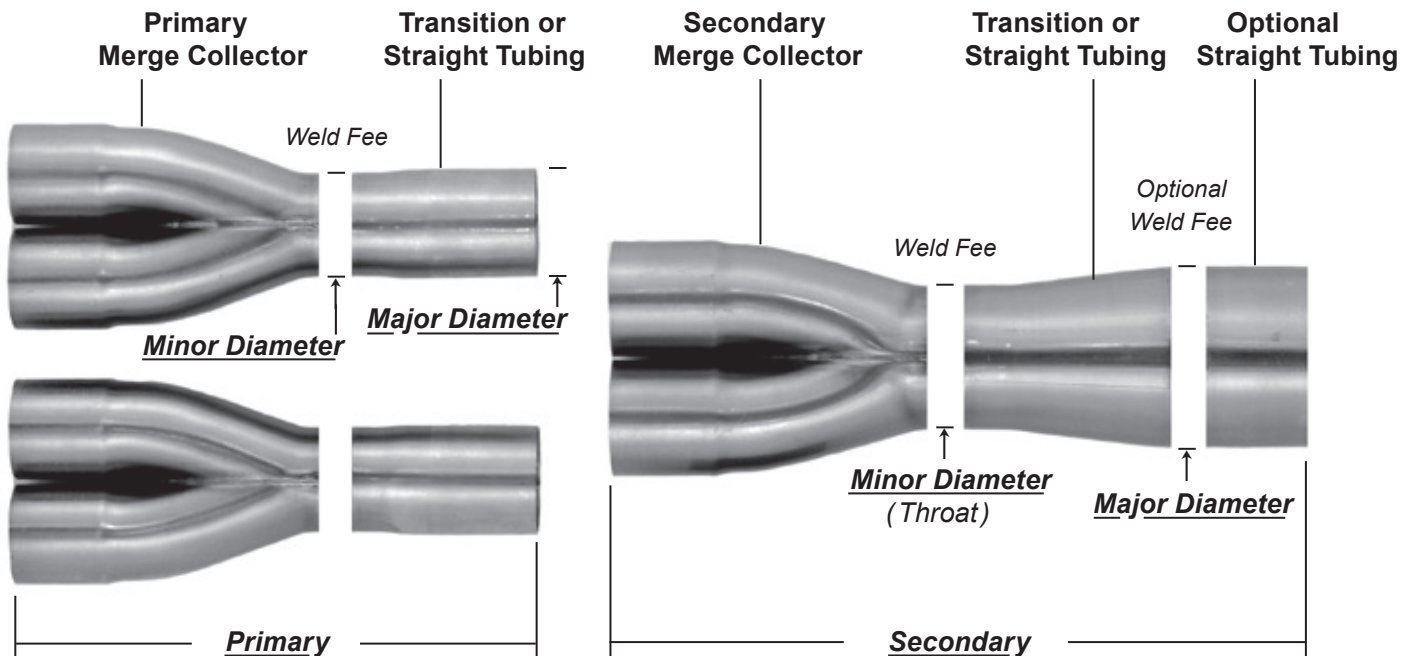

Tri-Y Welded

Available Options

- ▶ 12°, 15°, 20°, 25° convergent angle
- ▶ 1.25" and up tube size
- ▶ 304, 321, 1008
- ▶ .065", .049", (.035" SST only) wall thickness

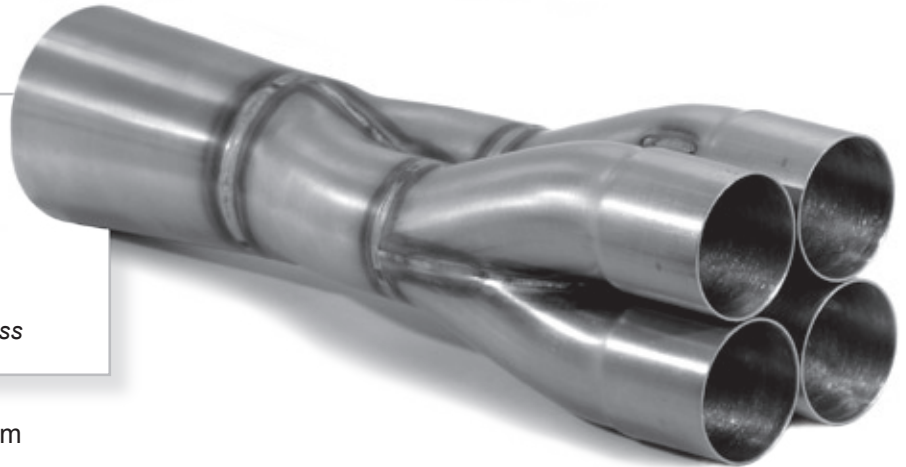

See page 2 for part numbering system

When Ordering Specify

- ▶ Assembled or Parts Only
- ▶ Throat Size (*Minor Diameter*)
- ▶ Outlet Options
(*Flanges, Transition, Tubing*)
- ▶ Custom Finish Work
(*Tabs, Bungs, Flanges*)

Welded Tri-Y collectors offer the same benefits as the slip-together but without the adjustability. Once you have settled on a design, a welded Tri-Y can be built to the same specifications as a slip together. The advantage is reduction in weight and/or space. For applications such as midgets and motorcycles, these are primary concerns.

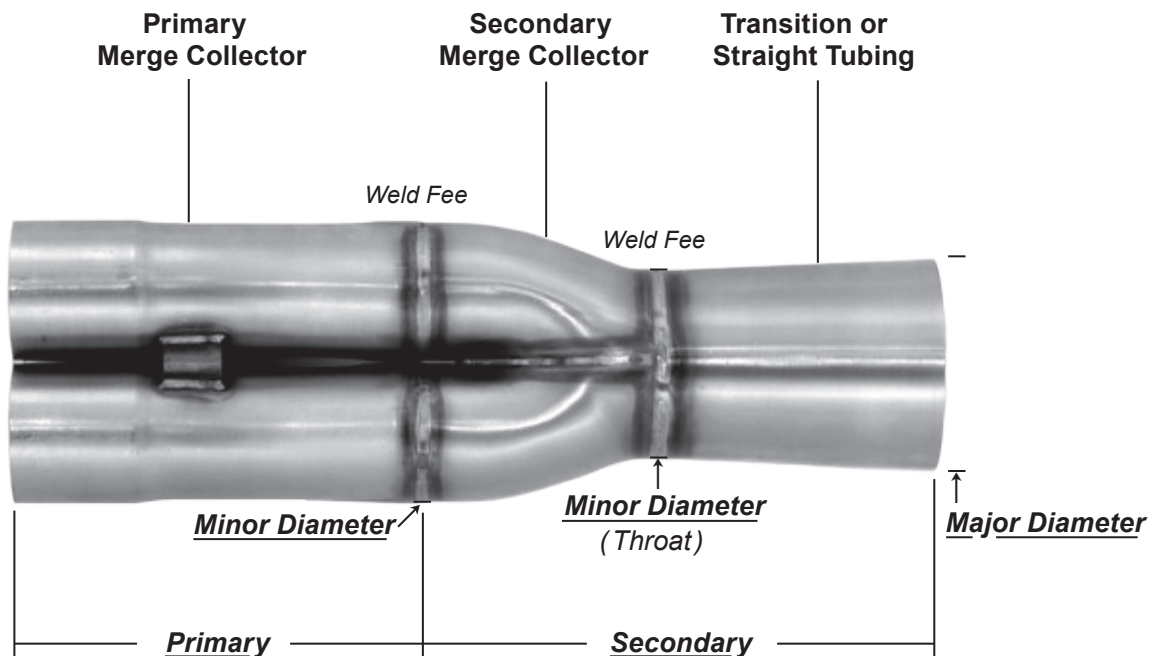



5 Way
WMC25188530416

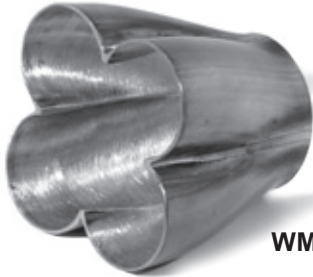

4 Way
WMC25188430416

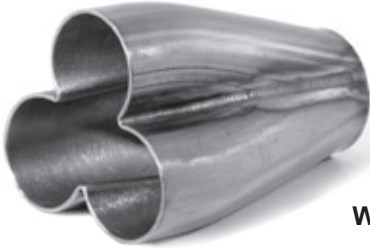

3 Way
WMC15150530416



2 Way
WMC20163230416

The advantage of a Weld-on Merge Collector is its size/length compared to a standard Merge Collector (see example below). The **WMC's** form is like that of a formed collector, but is constructed like a merge collector to provide the material strength necessary to withstand the stresses of a turbo application. Its construction allows for smaller outlet sizes than are possible with a formed collector.

WMC's are made using a tube one size larger than the primary tubes on your application, allowing them to seat just inside the collector. After the welded assembly is complete, the straight inlet section is reduced and the center pyramid is removed.

Available Options

- ▶ 12°, 15°, 20°, 25° convergent angle
- ▶ 1.25" - 3.50" tube size
- ▶ 2 way - 6 way
- ▶ 304, 321, 1008
- ▶ .065", .049", (.035" SST only) wall thickness

See page 2 for part numbering system

When Ordering Specify

- ▶ Throat Size (*Minor Diameter*)
- ▶ Outlet Options
(*Flanges, Transition, Tubing*)
- ▶ Custom Finish Work
(*Tabs, Bungs, Wastegate Tube*)

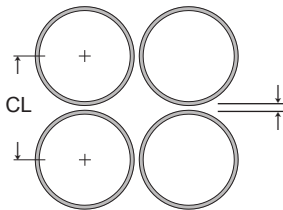

Turbo Style WMC's are built with a slightly wider centerline. This leaves a gap between each of the header pipes allowing for expansion. Use shims to maintain this spacing when welding the collected header tubes together.

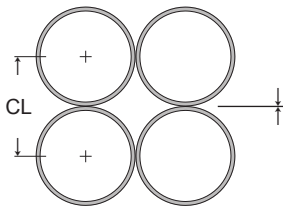

Street Style WMC's are designed for header tubes that are collected together with a net fit (no clearance). This makes them easy to assemble.

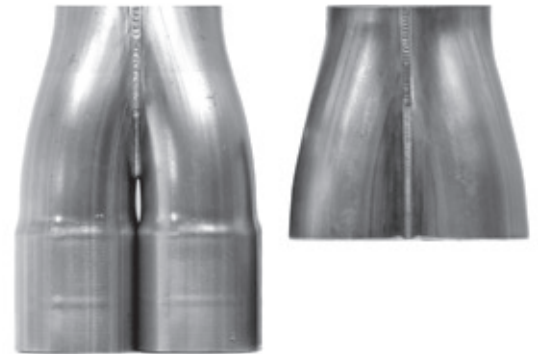

MC vs. WMC

MC25175-4-30418 vs. WMC25175-4-30418

Y-Collectors & X-Pipes (YC)

SPD Y-Collectors are made the same as a 25 degree 2-way Merge Collector. The difference is a wider inlet centerline to provide space between the legs.

On the table at the bottom of the page you will find the standard **inlet center lines**



Sportsman
shown w/ V-Band inlet & outlet
(Typical Late Model Stock Car)



Double Slip
shown w/ CWT100 Wing Tabs
(Typical SCCA Trans-Am)

- When Ordering Specify**
- ▶ Throat Size (*Minor Diameter*)
 - ▶ Outlet Options
(*Flanges, Transition, Tubing*)
 - ▶ Custom Finish Work
(*Tabs, Bungs, Wastegate Tube*)

Ask about custom fabrication as shown above

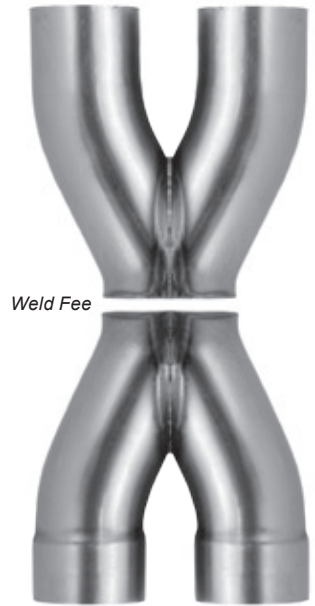

Double Slip
Both Legs Swedged



Sportsman
One Leg Swedged



Straight Inlets
No Swedging



X-Pipe

Inlet Tube Size (ID)	SPD Part #	Inlet Center Line	Outlet Sizes (OD)
(2) 2.00"	YC200	3.00	2.13" - 3.00"
(2) 2.25"	YC225	3.25	2.25" - 3.00"
(2) 2.50"	YC250	3.50	2.50" - 3.50"
(2) 2.75"	YC275	3.75	2.75" - 3.50"
(2) 3.00"	YC300	4.25	3.00" - 4.00"
(2) 3.50"	YC350	5.00	3.50" - 4.50"

YC 200 - 304 16

For stainless steel use -304 or -321

For mild steel leave blank

16ga. 18ga. 20ga.

Style Inlet Tube O.D. Material Type (Optional) Gauge Wall Thickness

(FC / SFC) Formed Collectors

Inlet Tube Size	2-WAY	3-WAY	4-WAY
1.25"	FC2125-150		FC4125-200
			FC4125-225
			FC4125-250
1.375"	FC2138-163		FC4138-225
			FC4138-250
1.50"	FC2150-175		
		FC3150-250	FC4150-250
		FC3150-300	FC4150-300
1.625"	FC2163-188		
		FC3163-250	FC4163-250
		FC3163-300	FC4163-300
1.750"	FC2175-200	FC3175-250	FC4175-300
		FC3175-300	FC4175-350
1.875"	FC2188-213	FC3188-300	FC4188-300
		FC3188-350	FC4188-350
2.00"	FC2200-225	FC3200-300	
		FC3200-350	FC4200-350
2.125"	FC2213-250		FC4213-350
			FC4213-400
2.25"	FC2225-275		FC4225-350
	FC2225-300		FC4225-400
			FC4225-450
2.375"	FC2238-300		FC4238-400
			FC4238-450
			FC4238-500
2.50"	FC2250-300		FC4250-400
			FC4250-450
			FC4250-500
2.625"			FC4263-450
			FC4263-500

Formed collectors are an economical way to collect header primary tubes together. This weld-on style is the most common of all header collectors still used today.

Several Formed Collectors are available in 304 stainless (Please inquire)

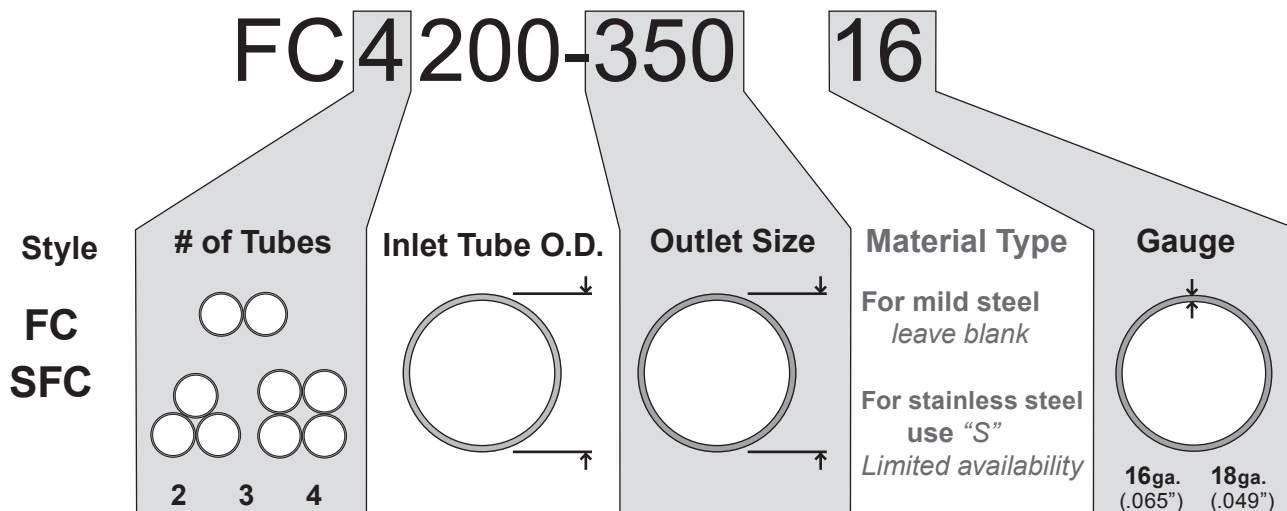



(FC) Stars

Designed to seal the center of your primary tubes when using a Weld-on style formed collector

Inlet Tube Size	4-WAY
1.500"	FCS150
1.625"	FCS163
1.750"	FCS175
1.875"	FCS188
2.000"	FCS200
2.125"	FCS213
2.225"	FCS225
2.375"	FCS238
2.500"	FCS250
2.625"	FCS263

(FC2) 2-Way Formed Collector



(FC3) 3-Way Formed Collector



(FC4) 4-Way Formed Collector



(SFC) Stars

Designed for use with the wider centerline of the swedged slips

Inlet Tube Size	4-WAY
1.500"	FCS150-213
2.125"	FCS213-263

(SFC) Slip-on Formed Collector

Swedged to fit advertised tube size



SPD Slip-on formed collectors utilize swedged slips (shown left) to provide a positive stop and seat for your primary tubes to seal against.

(CT) Collector Transitions

Minor Tube OD	3-degree taper	OAL	7-degree taper	13-degree taper	Major Tube OD
1.25"	CT1253-138		CT1257-138	CT125-138	1.375
	CT1253-150		CT1257-150	CT125-150	1.500
	CT1253-163		CT1257-163	CT125-163	1.625
	CT1253-175		CT1257-175	CT125-175	1.750
			CT1257-188	CT125-188	1.875
			CT1257-200	CT125-200	2.000
1.375"	CT1383-150		CT1387-150	CT138-150	1.500
	CT1383-163		CT1387-163	CT138-163	1.625
	CT1383-175		CT1387-175	CT138-175	1.750
	CT1383-188		CT1387-188	CT138-188	1.875
			CT1387-200	CT138-200	2.000
			CT1387-213	CT138-213	2.125
1.50"	CT1503-163		CT1507-163	CT150-163	1.625
	CT1503-175		CT1507-175	CT150-175	1.750
	CT1503-188		CT1507-188	CT150-188	1.875
	CT1503-200		CT1507-200	CT150-200	2.000
			CT1507-213	CT150-213	2.125
			CT1507-225	CT150-225	2.250
1.625"	CT1633-175		CT1637-175	CT163-175	1.750
	CT1633-188		CT1637-188	CT163-188	1.875
	CT1633-200		CT1637-200	CT163-200	2.000
	CT1633-213		CT1637-213	CT163-213	2.125
			CT1637-225	CT163-225	2.250
			CT1637-238	CT163-238	2.375
	MEG31535	30"			3.500
1.75"	CT1753-188		CT1757-188	CT175-188	1.875
	CT1753-200		CT1757-200	CT175-200	2.000
	CT1753-213		CT1757-213	CT175-213	2.125
	CT1753-225		CT1757-225	CT150-225	2.250
			CT1757-238	CT175-238	2.375
			CT1757-250	CT175-250	2.500
	MEG31730	17.5"			3.000
MEG61735	17.5"			3.500	
1.875"	CT1883-200		CT1887-200	CT188-200	2.000
	CT1883-213		CT1887-213	CT188-213	2.125
	CT1883-225		CT1887-225	CT188-225	2.250
	CT1883-238		CT1887-238	CT188-238	2.375
			CT1887-250	CT188-250	2.500
2.00"	CT2003-213		CT2007-213	CT200-213	2.125
	CT2003-225		CT2007-225	CT200-225	2.250
	CT2003-238		CT2007-238	CT200-238	2.375
	CT2003-250		CT2007-250	CT200-250	2.500
			CT2007-275	CT200-275	2.750
				CT200-300	3.000
MEG62040-18	17.5"			4.000	
2.125"	CT2133-225		CT2137-225	CT213-225	2.250
	CT2133-238		CT2137-238	CT213-238	2.375
	CT2133-250		CT2137-250	CT213-250	2.500
			CT2137-275	CT213-275	2.750
			CT2137-300	CT213-300	3.000

Add a "S" for 304 stainless steel
example: (CT3007-350**S**16)

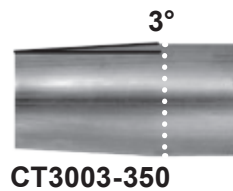
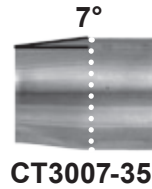
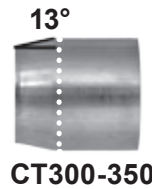

(MEG) Megaphones



Are rolled and seam welded
18ga. 1008 mild or 304
stainless steel

*These parts can be cut to
provide the desired inlet and
outlet O.D. for your specific
application*



MEG62040-S18

Collector Transitions (CT)

	Minor Tube O.D	3-degree taper	7-degree taper	13-degree taper	Major Tube OD	
T100 CT350-T10030416 	2.25"			CT225-T03()16	Rectangle	
		CT2253-250	CT2257-250	CT225-250	2.500	
		CT2253-275	CT2257-275	CT225-275	2.750	
			CT2257-300	CT225-300	3.000	
	2.375"			CT238-T03()16	Rectangle	
		CT2383-250	CT2387-250	CT238-250	2.500	
		CT2383-275	CT2387-275	CT238-275	2.750	
			CT2257-300	CT225-300	3.000	
				CT250-T03()16	Rectangle	
				CT250-T04()16	Rectangle	
T04 CT300-T0430416 	2.50"					
		CT2503-275	CT2507-275	CT250-275	2.750	
		CT2503-300	CT2507-300	CT250-300	3.000	
			CT2507-325	CT250-325	3.250	
			CT2507-350	CT250-350	3.500	
		MEG62545-18	17.5		4.500	
	T03 CT225-T0330416 	2.625"	CT2633-275	CT2633-275	CT263-275	2.750
			CT2633-300	CT2637-300	CT263-300	3.000
				CT2637-325	CT263-325	3.250
				CT2637-350	CT263-350	3.500
2.75"				CT275-T04()16	Rectangle	
		CT2753-300	CT2757-300	CT275-300	3.000	
		CT2753-325	CT2757-325	CT275-325	3.250	
			CT2757-350	CT275-350	3.500	
3.00"				CT300-T04()16	Rectangle	
				CT300-T100()16	Rectangle	
		use below	CT3007-325	CT300-325	3.250	
		CT3003-350	CT3007-350	CT300-350	3.500	
			CT3007-375	CT300-375	3.750	
			CT3007-400	CT300-400	4.000	
		MEG63050-18	17.5		5.000	
3.25"				CT325-T100()16	Rectangle	
		CT3253-350	CT3257-350	CT325-350	3.500	
			CT3257-375	CT325-375	3.750	
			CT3257-400	CT325-400	4.000	
3.50"		use below	CT3507-375	CT350-375	3.750	
		CT3503-400	CT3507-400	CT350-400	4.000	
			CT3507-425	CT350-425	4.250	
			CT3507-450	CT350-450	4.500	
4.00"		use below	CT4007-425	CT400-425	4.250	
		CT4003-450	CT4007-450	CT400-450	4.500	
			CT4007-500	CT400-500	5.000	
4.50"		CT4503-500	CT4507-500	CT450-500	5.000	
			CT4507-550	CT450-550	5.500	
5.00"		CT5003-550	CT5007-550	CT500-550	5.500	
			CT5007-600	CT500-600	6.000	

Turbo Transitions

Are available:

- ▶ 16 ga. only
- ▶ 304 SST
- ▶ 321 SST
- ▶ 1008 mild steel

Turbo transitions are made to fit
 SPD turbo flanges
 (see page 40 for port dimensions)

Collector Retainers

(CWTK) Wing Tab



	Part #	Description
Kits	CWTK100	(2) CWT100, (1) 10-32 bolt, (2) AN washers, (1) lock nut
	CWTK100S	(2) CWT100S, (1) 10-32 bolt, (2) AN washers, (1) lock nut
Individual Parts	CWT100	Collector Wing Tab
	CWT100S	Collector Wing Tab (304 Stainless)
	AN3-24A	10-32 x 2.50" UHL Bolt
	AN3-30A	10-32 x 3.00" UHL Bolt
	AN960-10	#10 AN Washer
	AN363-10	10-32 Mechanical Lock Nut

(STK) Spring Tab



	Part #	Description
Kits	STK100	(2) ST100 & (1) CS300
	STK100S	(2) ST100S & (1) CS300
Individual Parts	ST100	Spring Tab
	ST100S	Spring Tab (304 stainless)
	CS300	Collector Spring (3.00" oal)

(ABK) A & B Tab



	Part #	Quantity
Kits	ABK100	A100 & B100 w/1/4-20 bolt & lock nut
	ABK100S	A100S & B100S w/1/4-20 bolt & lock nut
Individual Parts	A100	A Tab
	A100S	A Tab - Stainless
	B100	B Tab
	B100S	B Tab - Stainless

Tube Size OD	SPD Part #	Overall Length
1.75"	SB175-4	4.00"
	SB175-6	6.00"
2.00"	SB200-4	4.00"
	SB200-6	6.00"
2.25"	SB225-6	6.00"
2.50"	SB250-6	6.00"
3.00"	SB300-6	6.00"

Other sizes available by special order

Standard Bellows (SB)



with internal flex liner

Features & Recommended Usage

- ▶ Standard bellows are typically used somewhere between the header collector and the muffler to absorb axial movement (engine and chassis flex).
- ▶ Not recommended for use in pre-turbo plumbing.

Tube Size OD	SPD Part #	Overall Length
2.50"	SJSB250-3	3.00"
3.00"	SJSB300-3	3.00"
3.50"	SJSB350-3	3.00"

Other sizes available by special order

Slip Joint Bellows (SJSB)



Features & Recommended Usage

- ▶ Slip Joint bellows are designed for use in high temperature and high pressure environments.
- ▶ 321 SST internal slip joint provides a smooth surface for directional flow.
- ▶ 625 inconel accordion style bellows absorb linear growth caused by heat expansion.
- ▶ Limited angular flex. Not made for axial movement.

(ZK) Zoomie Kits

Top Fuel (ZKTF) Top Alcohol Dragster

Kit Includes: (8) *125 degree bends*

(A) Leg = 6"

(B) Leg = 6"



125° on a 6.0" clr.

Available Options

- ▶ 2.25"- 2.50" on a 6.0" clr
- ▶ 304 or 1008
- ▶ .065 wall thickness

Funny Car (ZKFC)

Kit Includes: (2) *79 degree bends*
(2) *82 degree bends*
(2) *85 degree bends*
(2) *88 degree bends*

(A) Leg = 4"

(B) Leg = 26"



88° 85° 82° 79°

Cover Tubes Available:
3" x .049 MS or SST



Available Options

- ▶ 2.00" on a 3.0" clr
- ▶ 2.25" on a 3.5" clr
- ▶ 2.50" on a 4.0" clr
- ▶ 304 or 1008
- ▶ .065 wall thickness

Puller Truck (ZKPT)

Kit Includes: (8) *125 degree bends*

(A) Leg = 4"

(B) Leg = 18"



125° on a 6.0" clr.

Available Options

- ▶ 2.00"- 2.50" on a 6.0" clr
- ▶ 304 or 1008
- ▶ .065 wall thickness

Mandrel Bends

How To Order

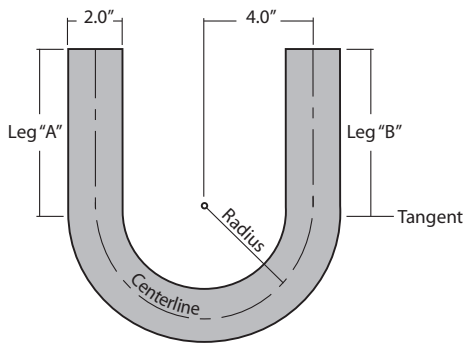

U bend 180°

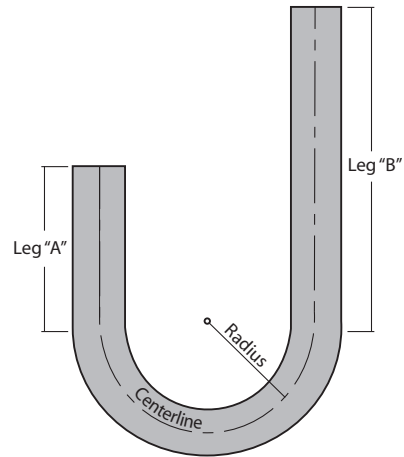

J bend 180°

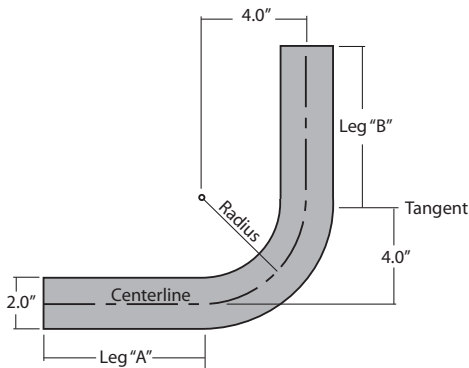

90° Bend

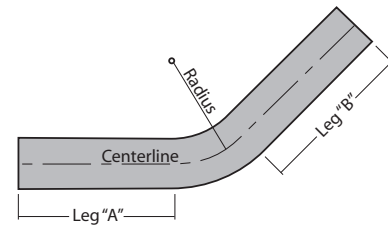

45° Bend

Tube O.D.	Material Type
	<p>For stainless steel use -304 or -321</p> <p>For mild steel leave blank</p>
<p>2</p> <p>200</p>	<p>30 - 304</p>
<p>16</p>	<p>16ga. 18ga. 20ga.</p>
<p>Bend Style</p>	<p>Centerline Radius</p>
<p>Wall Thickness</p>	<p>Gauge</p>

Mandrel Bends

Tube Size (OD)	Center Line Radius	Part # U-bend	Part # J-bend	Part # 90-bend	Part # 45-bend
1.00"	2.00	*****	Available in 2007	*****	
	1.125"	2.00	*****	Available in 2007	*****
1.25"	2.50	112525	212525	312525	412525
	4.00	*****	Available in 2007	*****	
1.375"	2.50	113825	213825	313825	413825
	4.00				
1.50"	2.00	115020	215020	315020	415020
	2.50	115025	215025	315025	415025
	3.00	115030	215030	315030	415030
	4.00	115040	215040	315040	415040
1.625"	2.00	116320	216320	316320	416320
	2.50	116325	216325	316325	416325
	3.00	116330	216330	316330	416330
	4.00	116340	216340	316340	416340
1.75"	2.00	117520	217520	317520	417520
	2.50	117525	217525	317525	417525
	3.00	117530	217530	317530	417530
	4.00	117540	217540	317540	417540
	5.00	117550	217550	317550	417550
	6.00	117560	217560	317560	417560
1.875"	2.00	118820*		318820	418820
	2.50	118825	218825	318825	418825
	3.00	118830	218830	318830	418830
	4.00	118840	218840	318840	418840
	5.00	118850	218850	318850	418850
	6.00	118860	218860	318860	418860
2.00"	2.00			320020	420020
	2.50	120025	220025	320025	420025
	3.00	120030	220030	320030	420030
	3.50	*****	Available in 2007	*****	
	4.00	120040	220040	320040	420040
	5.00	120050	220050	320050	420050
	6.00	120060	220060	320060	420060
	8.00			320080	420080
2.125"	2.50	121325	221325	321325	421325
	3.00	121330	221330	321330	421330
	3.50	121335	221335	321335	421335
	4.00	121340	221340	321340	421340
	5.00	121350	221350	321350	421350
	6.00	121360	221360	321360	421360

"U" bends, 45's, and 90's

 Denotes
6" leg lengths

"J" bends

 Denotes
6" & 12" leg lengths

"U" bends, 45's, and 90's





 Denotes
8" leg lengths

"J" bends

 Denotes
8" & 15" leg lengths

P/N *118820
is bent 150 degrees

Mandrel Bends

	Tube Size (OD)	Center Line Radius	Part # U-bend	Part # J-bend	Part # 90-bend	Part # 45-bend	
"U" bends, 45's, and 90's  Denotes 6" leg lengths	2.25"	2.25			322522	422522	
		2.50	*****	Available in 2007		*****	
		3.00	122530	222530	322530	422530	
		3.50	122535	222535	322535	422535	
		4.00	122540	222540	322540	422540	
		6.00	122560	222560	322560	422560	
"J" bends  Denotes 6" & 12" leg lengths	2.375"	2.38			323824	423824	
		3.00	123830	223830	323830	423830	
		3.50	123835	223835	323835	423835	
		4.00	123840	223840	323840	423840	
		6.00	123860	223860	323860	423860	
"U" bends, 45's, and 90's  Denotes 8" leg lengths	2.50"	2.50			325025	425025	
		3.00	125030	225030	325030	425030	
		3.50	*****	Available in 2007		*****	
		4.00	125040	225040	325040	425040	
		5.00	125050	225050	325050	425050	
		6.00	125060	225060	325060	425060	
"U" bends, 45's, and 90's  Denotes 8" & 15" leg lengths	2.625"	4.00	126340	226340	326340	426340	
		6.00	*****	Available in 2007		*****	
"J" bends	2.75"	2.75			327527	427527	
		4.00	127540	227540	327540	427540	
		5.50	127555		327555	427555	
		6.00	*****	Available in 2007		*****	
"J" bends  Denotes Varied leg lengths most less than 4.00"	3.00"	3.00			330030	430030	
		3.50	*****	Available in 2007		*****	
		4.00	130040	230040	330040	430040	
		6.00	130060	230060	330060	430060	
"J" bends	3.50"	3.50			335035	435035	
		6.00	135060		335060	435060	
		7.00	135070		335070	435070	
"J" bends	4.00"	4.00			340040	440040	
		8.00	140080		340080	440080	
"J" bends	4.50"	4.50			345045	445045	
		9.00	145090		345090	445090	
"J" bends	5.00"	5.00			350050	450050	
		10.00	150010		350010	450010	



(ST) Straight Tubing

Tube Size OD	SPD Part #	Wall Thickness	Materials Available
1.00	ST10020	.035	304
	ST10018	.049	1008, 304, 321
	ST10016	.063	1008, 304
1.125"	ST11320	.035	304
	ST11318	.049	1008, 304, 321
	ST11316	.063	1008, 304
1.25"	ST12520	.035	304, 321
	ST12518	.049	1008, 304, 321
	ST12516	.063	1008, 304,
1.375"	ST13820	.035	304, 321
	ST13818	.049	1008, 304, 321
	ST13816	.063	1008, 304
1.50"	ST15020	.035	304, 321
	ST15018	.049	1008, 304, 321
	ST15016	.063	1008, 304, 321, 6061
1.625"	ST16320	.035	304, 321
	ST16318	.049	1008, 304, 321
	ST16316	.063	1008, 304, 321
1.75"	ST17520	.035	304, 321
	ST17518	.049	1008, 304, 321
	ST17516	.063	1008, 304, 321, 6061
1.875"	ST18820	.035	304, (321 Special Order)
	ST18818	.049	1008, 304, 321
	ST18816	.063	1008, 304, 321
2.00"	ST20020	.035	304, 321
	ST20018	.049	1008, 304, 321
	ST20016	.063	1008, 304, 321, 6061
2.125"	ST21320	.035	304, 321
	ST21318	.049	1008, 304, 321
	ST21316	.063	1008, 304
2.25"	ST22520	.035	304, 321
	ST22518	.049	1008, 304, 321
	ST22516	.063	1008, 304, 321, 6061
2.375"	ST23820	.035	304
	ST23818	.049	1008, 304, 321
	ST23816	.063	1008, 304
2.50"	ST25020	.035	304, 321
	ST25018	.049	1008, 304, 321
	ST25016	.063	1008, 304, 321, 6061

Straight Tubing (ST)

Tube Size OD	SPD Part #	Wall Thickness	Materials Available
2.625"	ST26320	.035	321
	ST26318	.049	1008, 304
	ST26316	.063	1008, 304
2.75"	ST27518	.049	1008, 304, 321
	ST27516	.063	1008, 304
3.00"	ST30020	.035	321
	ST30018	.049	1008, 304, 321
	ST30016	.063	1008, 304, 321, 6061
3.25"	ST32516	.063	1008, 304
3.50"	ST35020	.035	321
	ST35018	.049	1008, 321
	ST35016	.063	1008, 304
4.00"	ST40020	.035	321
	ST40018	.049	321
	ST40016	.063	1008, 304
4.50"	ST45016	.063	1008, 304
5.00"	ST50016	.063	1008, 304

Tube Extensions (TE)

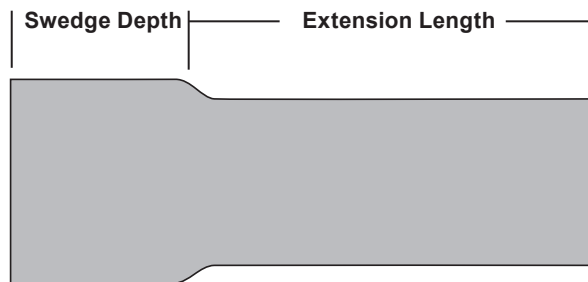

Tube extensions are available in most tube sizes and lengths.

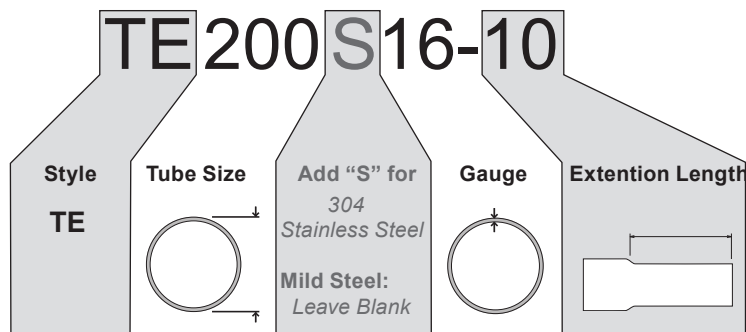

Header Flanges

See page 50 for How to Make a pencil transfer (Rubbing)

SBC Small Block Chevrolet

4.3 V6



C600xx OEM

C60052 1.63" Square (SAP)
C60053 1.75" Square (SAP)

◆ Bolt Spacing 2.22"



C604xx 18-deg V6

C60464 1.88" Square
C60465 2.00" Square

◆ Bolt Spacing 2.48"

Where individual flanges are shown
Add "E" & "C" to the part number

OEM Bolt Pattern



C800xx Gen I Small Block 55-02

C80022 1.63" Round
C80043 1.75" Oval
C80052 1.63" Square (SAP)
C80053 1.75" Square (SAP)
C80054 1.88" Square (SAP)

◆ Outer Bolt Spacing 2.22"
◆ Inner Bolt Spacing 3.94"

Add "C" & "E" for individual flanges
(C800xx-C) (C800xx-E)



C803xx Gen II LT1-ZZ3-ZZ4

C80332 1.63" D (SAP)
C80333 1.75" D (SAP)

◆ Outer Bolt Spacing 2.22"
◆ Inner Bolt Spacing 3.94"

Add "C" & "E" for individual flanges
(C803xx-C) (C803xx-E)



C835xx Gen II Fastburn GM p/n 12464298

C83532 1.63" D (SAP)
C83533 1.75" D (SAP)



C811xx Gen III LS-1/LS-6

C81123 1.75" Round
C81124 1.88" Round
C81125 2.00" Round
C81142 1.63" Oval
C81143 1.75" Oval
C81144 1.88" Oval



C805xx Gen III LS-7

C80524 1.88" Round
C80525 2.00" Round
C80553 1.75" D (SAP)
C80554 1.88" D (SAP)



C804xx GM Perf 18-deg

C80444 1.88" Square Oval
C80445 2.00" Square Oval
C80444RP 1.88" Raised Port
C80445RP 2.00" Raised Port

◆ Outer Bolt Spacing 2.48"
◆ Inner Bolt Spacing 4.62"



C806xx SB2/SB2.2

C80624 1.88" Round
C80625 2.00" Round
C80642 1.63" Square Oval
C80644 1.88" Square Oval
C80645 2.00" Square Oval

Small Block Chevrolet SBC

Standard 7 Bolt Pattern

Photo Not Available

C815xx Brodix -8 & -10

- C81563 1.75" Square
- C81564 1.88" Square



C829xx Pontiac 867 Chapman-10X / All Pro 227 (Can be used with AC80120 Adapters)

- C82963 1.75" Square
- C82964 1.88" Square
- C82965 2.00" Square

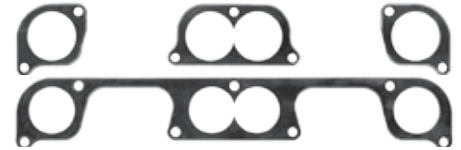

C802xx Outer Flange For use with AC80120 Adapters

- C80223 1.75" Round
- C80224 1.88" Round
- C80225 2.00" Round
- C80226 2.13" Round

Shown as one kit



Uses low head allen bolts

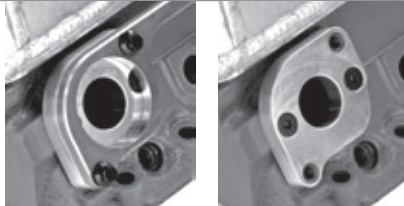

AC80120 Aluminum Adapter Flanges

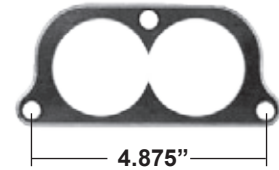

The standard 7 bolt pattern is identified by the 4.875" bottom center bolt spacing

Spread Port 7 Bolt Pattern



C812xx (top bar)

Brodix 12 & 18° ~ Chapman 18° ~ All Pro 18°

- C81224 1.88" Round
- C81225 2.00" Round
- C81226 2.13" Round
- ◆C81244 1.88" Oval



C813xx (middle bar)

- C81324 1.88" Round
- C81325 2.00" Round
- C81326 2.13" Round
- ◆C81344 1.88" Oval



C814xx Chapman -10x SP

- C81463 1.75" Square
- C81464 1.88" Square
- C81465 2.00" Square

◆ Same port shape as GM 18° flange C804xx



C816xx Brodix 12x12 (top bar)

- C81634 1.88" D (SAP)
- C81635 2.00" D (SAP)
- C81636 2.13" D (SAP)



C818xx Brodix -10&11SP (top bar) Weldtech 23SP/AFR220 23SP

- C81824 1.88" Round
- C81825 2.00" Round
- C81826 2.13" Round
- C81833 1.75" D (SAP)
- C81834 1.88" D (SAP)



C830xx All Pro 227SP (top bar)

- C83053 1.75" SAP
- C83054 1.88" SAP
- C83055 2.13" SAP

Where individual flanges are shown
Add "L", "R", & "C" to the part number



C843xx Dart 15&18° / Olds 14°

- C84324 1.88" Round
- C84325 2.00" Round
- C84326 2.13" Round

SBC Small Block Chevrolet

Hooker 7 Bolt Pattern



C834xx Hooker Outer Flange

C83424	1.88"	Round
C83425	2.00"	Round
C83426	2.13"	Round



**C848xx Dominion 32-Valve
Aero Engineering**

C84855	2.00"	SAP
C84856	2.13"	SAP

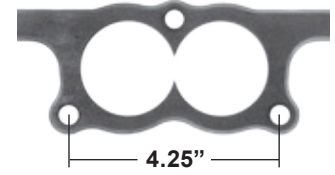

The Hooker Bolt Pattern is identified by the 4.25 bottom center bolt spacing

Alan Johnson



C822xx AJPE 18° & 23°

C82224	1.88"	Round
C82225	2.00"	Round
C82226	2.13"	Round

Canted / Splayed Valve

Also Shown on page 28 as Buick



B837xx SBC/ Buick Dart V8

B83764	1.88"	Square
B83765	2.00"	Square
B83766	2.13"	Square



C817xx Brodix BD2000

C81724	1.88"	Round
C81725	1.88"	Round
C81726	2.13"	Round

Add "I" for individual flanges (C817xx-I)



C819xx Brodix BD1010

C81924-I	1.88"	Round
C81925-I	2.00"	Round



C820xx GM Splayed Valve

C82023	1.75"	Round
C82024	1.88"	Round
C82025	2.00"	Round

Add "I" for individual flanges (C820xx-I)



C842xx Dart "Little Chief"

C84224	1.88"	Round
C84225	2.00"	Round
C84226	2.13"	Round
C84243	1.75"	(Sqr-Oval)
C84244	1.88"	(Sqr-Oval)
C84245	2.00"	(Sqr-Oval)

Add "I" for individual flanges (C842xx-I)



C845xx Assassin 4.5 bore ctr.

C84555	2.00"	SAP
C84556	2.13"	SAP
C84557	2.25"	SAP

Add "I" for individual flanges (C845xx-I)

Big Block Chevy BBC

STD Bore Center (4.84)



C850xx OEM Square

C85055	2.00"	Square (SAP)
C85056	2.13"	Square (SAP)
C85057	2.25"	Square (SAP)



C851xx Brodix/Dart/OEM Round

C85125	2.00"	Round
C85126	2.13"	Round
C85127	2.25"	Round
C85128	2.38"	Round
C85129	2.50"	Round



C857xx Edelbrock GM 502-572 Alum

C85735	2.00"	D-Port
C85736	2.13"	D-Port
C85737	2.25"	D-Port

Add "I" for individual flanges (C851xx-I)



C852xx Dart 320-360 / Olds-14°

C85257	2.25"	Rect. (canted)
C85258	2.38"	Rect. (canted)
C85259	2.50"	Rect. (canted)



C853xx Dart Big Chief

C85337	2.25"	D-Port
C85338	2.38"	D-Port
C85379	2.50"	D-Port



C856xx CFE BMF

C85656	2.13"	Square (SAP)
C85657	2.25"	Square (SAP)
C85658	2.38"	Square (SAP)

Wide Bore Center (5.00)



C854xx 5.00" Bore Center

C85427	2.25"	Round
C85428	2.38"	Round
C85429	2.50"	Round



C855xx Sonny's 5.00 Bore Center

C85527	2.25"	Round
C85528	2.38"	Round
C85529	2.50"	Round

For individual flanges use
C851xx-I Brodix/Dart/OEM Round

Port offset left .180"

DRCE



C826xx Chev BB/Olds DRCE 4.84 Bore Center

C82626	2.13"	Round
C82627	2.25"	Round
C82628	2.38"	Round
C82629	2.50"	Round



C828xx Olds DRCE II 4.9 Bore Center

C82826	2.13"	Round
C82827	2.25"	Round
C82828	2.38"	Round
C82829	2.50"	Round

GM

Buick



B639xx Buick Stage II V6

B63964 1.88" Square
B63965 2.00" Square

◆ Will Not Fit OEM Buick V6



B837xx Chev SB / Buick Dart V8

B83764 1.88" Square
B83765 2.00" Square
B83766 2.13" Square

Also Shown on page 26 as SBC

◆ Will Not Fit OEM Buick V8

Pontiac



P858xx Edelbrock 400-455

P85833 1.75" D-Port
P85834 1.88" D-Port
P85835 2.00" D-Port
P85836 2.13" D-Port

◆ Will Not Fit OEM Pontiac Head



C829xx Pontiac 867 Chapman-10X / All Pro 227 (Can be used with AC80120 Adaptors)

C82963 1.75" Square
C82964 1.88" Square
C82965 2.00" Square

Oldsmobile



O827xx Edelbrock 400-455

O82764 1.88" Square
O82765 2.00" Square

◆ Will Not Fit OEM Olds Head



C826xx Chev BB/Olds DRCE 4.84 Bore Center

C82627 2.25" Round
C82628 2.38" Round
C82629 2.50" Round



C828xx Chev BB/Olds DRCE II 4.9 Bore Center

C82827 2.25" Round
C82828 2.38" Round
C82829 2.50" Round

Cadillac



C8160xx Cadillac Northstar

C816042 1.63" Oval
C816043 1.75" Oval
C816044 1.88" Oval
C816045 2.00" Oval
C816074 1.88" Round Counterbore
C816075 2.00" Round Counterbore

Ford

Modular



F859xx 4.6-5.4L SOHC

F85922	1.63"	Round
F85923	1.75"	Round
F85924	1.88"	Round



F872xx 4.6-5.4L DOHC

F87243	1.75"	Oval
F87244	1.88"	Oval
F87245	2.00"	Oval
F87246	2.13"	Oval
2004 & Up F87253	1.75"	D-Oval
F87254	1.88"	D-Oval



F8115xx R50 DOHC 5.4L GT / 5.0L Cammer

F811554	1.88"	Oval
F811555	2.00"	Oval

◆ Not for 2004 & up 3 valve heads

Windsor



F869xx SVO I/Y302 OEM (2.0" bolt cl)

F86911	1.50"	Rectangle (SAP)
F86912	1.63"	Rectangle (SAP)
F86913	1.75"	Rectangle (SAP)

Add "I" for individual flanges (F869xx-I)



F8139xx Edelbrock Victor Jr. (2.0" bolt cl)

F813951	1.50"	Rectangle (SAP)
F813952	1.63"	Rectangle (SAP)
F813953	1.75"	Rectangle (SAP)

Add "I" for individual flanges (F8139xx-I)

Photo Not Available

F8140xx Roush Crate Motors (2.0" bolt cl)

F814032	1.63"	(SAP)
F814033	1.75"	(SAP)



F873xx Edelbrock #7721 (2.5" bolt cl)

F87362	1.63"	Square
F87363	1.75"	Square
F87364	1.88"	Square
F87365	2.00"	Square



F8117xx SVO N352 "Cast Iron" (2.75" bolt cl)

F811763	1.75"	Square
F811764	1.88"	Square



F870xx Brodix Track 1 SVO N/R/S351 "Sportsman" (2.75" bolt cl)

F87063	1.75"	Square
F87064	1.88"	Square
F87065	2.00"	Square



F865xx SVO E351 / Dart 351 (3.0" bolt cl)

F86563	1.75"	Square
F86564	1.88"	Square
F86565	2.00"	Square

Add "I" for individual flanges (F865xx-I)



F868xx SVO J302 Windsor (formerly Alan Root)

F86833	1.75"	D-Port
F86834	1.88"	D-Port



F871xx TFS R Series & Hi Port

F87163	1.75"	Square
F87164	1.88"	Square
F87165	2.00"	Square

Shown as one kit



Uses low head allen bolts

AF812020 Aluminum Adapter Set

6061 Aluminum w/ steel thread inserts

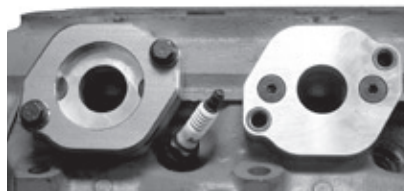

Adapter Plate Adapter Plate
& Individual Flange



F8126xx Ford SB Outer Flange (For SPD Adapters)

F812623	1.75"	Round
F812624	1.88"	Round
F812625	2.00"	Round

Add "I" for individual flanges (F8126xx-I)

Boss 302 - 351C - 351/400M



F874xx Cleveland 2V

- F87463 1.75" Oval
- F87464 1.88" Oval
- F87465 2.00" Oval



F875xx Cleveland 4V/ BOSS 302 351/400 Midland

- F87556 2.13" Square (SAP)

Yates - SVO - Roush



F876xx Brodix / Neal BF200

- F87624 1.88" Round
- F87625 2.00" Round
- F87626 2.13" Round



F877xx Brodix / Neal BF301

- F87763 1.75" Rectangle
- F87764 1.88" Rectangle
- F87765 2.00" Rectangle

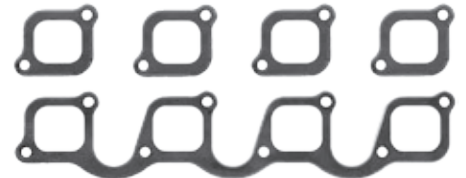

F863xx SVO C3/C33 Yates NASCAR

- F86363 1.75" Rectangle (SAP)
- F86364 1.88" Rectangle (SAP)
- F86365 2.00" Rectangle (SAP)

Add "I" for individual flanges (F863xx-I)

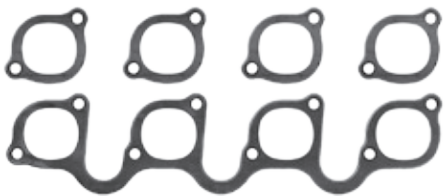

F878xx SVO/Chapman SC-1

- F87844 1.88" Oval (SAP)
- F87845 2.00" Oval (SAP)
- F87846 2.13" Oval (SAP)

Add "I" for individual flanges (F878xx-I)



F879xx SVO/Chapman SC-1R Raised Port

- F87944 1.88" Oval (SAP)
- F87945 2.00" Oval (SAP)
- F87846 2.13" Oval (SAP)

Add "I" for individual flanges (F879xx-I)

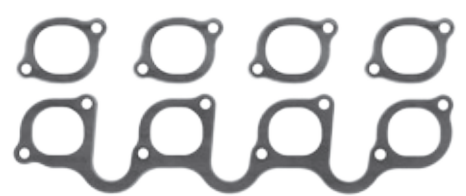

F8142xx Chapman D35

- F814244 1.88" Oval (SAP)
- F814245 2.00" Oval (SAP)
- F814246 2.13" Oval (SAP)

Add "I" for individual flanges (F8142xx-I)

Ford

“FE” 360-428



F867xx Edelbrock GTA (4 bolt)

F86715	2.00"	Rectangle
F86716	2.13"	Rectangle
F86717	2.25"	Rectangle



F866xx Edelbrock (2 bolt)

F86615	2.00"	Rectangle
F86616	2.13"	Rectangle
F86617	2.25"	Rectangle

Please inquire about OEM “FE” 360-390-427-428

BBF 429-460



F860xx (old style 1969-1987)

F86044	1.88"	Oval
F86045	2.00"	Oval



F861xx (new style EFI 1988-)

F86134	1.88"	Square (SAP)
F86135	2.00"	Square (SAP)



F862xx SVO A/B429 Cobra Jet (aluminum head only)

F86246	2.13"	Oval
F86247	2.25"	Oval
F86248	2.38"	Oval

Big Block (Racing Heads)



F8118xx SVO E460

F811826	2.13"	Round
F811827	2.25"	Round
F811828	2.38"	Round
F811829	2.50"	Round



F8129xx Blue Thunder

F812956	2.13"	SAP
F812957	2.25"	SAP
F812978	2.38"	Round Counter Bore
F812979	2.50"	Round Counter Bore



F864xx SVO C/D460 Pro Stock/ Pro Mod

F86467	2.25"	Square (SAP)
F86468	2.38"	Square (SAP)
F86469	2.50"	Square (SAP)

Hemi Drag Racing Heads



F8124xx SVO A441 / B441 (4.9 Bore Center)

F812447	2.25"	Oval (SAP)
F812448	2.38"	Oval (SAP)
F812449	2.50"	Oval (SAP)



F8135xx SVO C441 (5.0 Bore Center)

F813547	2.25"	Oval (SAP)
F813548	2.38"	Oval (SAP)
F813549	2.50"	Oval (SAP)



F81364xx SVO C441 Jon Kasse (5.0 Bore Center)

F8136410	2.63"	Square (SAP)
----------	-------	--------------

Mopar

Small Block



M880xx 273-360

M88052 1.63" SAP
M88053 1.75" SAP



M881xx W2

M88153 1.75" SAP
M88154 1.88" SAP
M88155 2.00" SAP



M896xx Brodix B1-BA

M89644 1.88" Square Oval
M89645 2.00" Square Oval

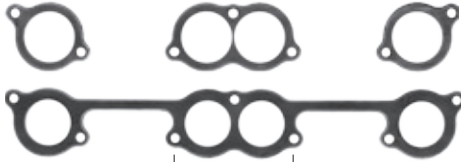

M891xx W8-Drag

M89124 1.88" Round
M89125 2.00" Round
M89126 2.13" Round

Add "L", "R", & "C" for individual flanges

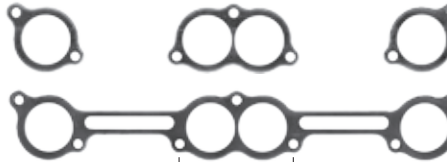

M883xx W8 & W9 (NASCAR)

M88324 1.88" Round
M88325 2.00" Round
M88326 2.13" Round
M88344 1.88" Square Oval

Add "L", "R", & "C" for individual flanges



M893xx W8 & W9 (.250 Raised Port)

M89324 1.88" Round
M89325 2.00" Round



M894xx Brodix B-1 Late Model Spec Head

M89452 1.62" SAP
M89453 1.75" SAP
M89454 1.88" SAP



M895xx P5 (Pro Stock Truck)

M89544-I 1.88" Oval
M88545-I 2.00" Oval



M897xx P7 (NASCAR)

M89723 1.75" Round
M89724 1.88" Round
M89725 2.00" Round

Wedge 361-440



M884xx 361-440 Wedge

M88415 2.00" Rectangle
M88416 2.13" Rectangle
M88417 2.25" Rectangle

Add "A" for Aluminum Head (M884xx-A)



M885xx Indy 572-600 series

M88517 2.25" Oval
M88518 2.38" Oval
M88519 2.50" Oval

Early Hemi 331-392



M886xx 331-354-392

M88645 2.00" Oval
M88646 2.13" Oval
M88647 2.25" Oval



M886xxZ 392 "Blown"

M88647Z 2.25" Oval
M88648Z 2.38" Oval
M88649Z 2.50" Oval



M892xx AJPE 392 Style Hemi "Nostalgia Top Fuel"

M89227 2.25" Round (Angled Up)
M89228 2.38" Round (Angled Up)
M89229 2.50" Round (Angled Up)

Both made with tapped holes for blower restraint brackets

426 Hemi & Keith Black Style



**M888xx 426 OEM (A)
Indy Cyl Head (B)**

- M88816A 2.13" Rectangle
- M88816B 2.13" Rectangle
- M88817 2.25" D-Port
- M88818 2.38" D-Port
- M88819 2.50" D-Port



M889xx 426 Dart / Keith Black

- M88915 2.00" Rectangle
- M88916 2.13" Rectangle
- M88937 2.25" D-Port
- M88938 2.38" D-Port
- M88939 2.50" D-Port
- M88955 2.00" SAP (KB)
- M88956 2.13" SAP (KB)



**M898xx AJPE Top Alcohol
(Late Model)**

- M89819 2.50" Round (Angled Up)

Photo Not Available

**M8109xx WAR Top Fuel
(Walt Austin Racing)**

- M810929 2.50" Round (Angled Up)



**M899xx AJPE Top Fuel
(Late Model)**

- M89929 2.50" Round (Angled Up)

Viper V-10



M10106xx-1 Viper V-10 Gen I

- M1010633-1 1.75" D-Port

◆ Sold as Individual Flanges Only



M10104xx Viper V-10 Gen II

- M1010433 1.75" D-Port
- M1010434 1.88" D-Port

Add "I" for individual flanges (M10104xx-I)

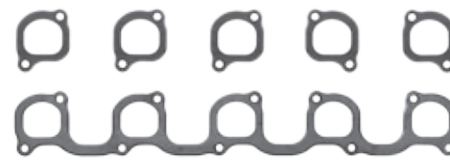

M10102xx Viper V-10 Gen III

- M1010233 1.75" D-Port
- M1010234 1.88" D-Port

Add "I-1" & "I-4" for individual flanges

Requires:

- (6) M101023x-I1
- (4) M101023x-I4

Sport Compact

BMW

Coming Soon

M42 / M44

Coming Soon

M50 / M52 S50 / S52

Ford / Mazda

Coming Soon

F41432x 2.0 - 2.3 Duratec

- F414322 1.63" Round
- F414323 1.75" Round
- F414324 1.88" Round

GM



2.0-2.2-2.4 Ecotec

Chevy, Pontiac, Saab, Saturn

- C415751 1.50" SAP oval
- ◆ C415772 1.63" SAP Counter bore
- ◆ C415773 1.75" SAP Counter bore



◆ Shown w/ counterbore port

Honda / Acura



H4204xx B Series

- H420423 1.75" Round
- H420424 1.88" Round
- H420442 1.63" Oval
- H420443 1.75" Oval
- H420444 1.88" Oval



H4206xx D Series

- H420642 1.63" Oval
- H420643 1.75" Oval



H4208xx H-22

- H420842 1.63" Oval
- H420843 1.75" Oval
- H420844 1.88" Oval



H4215xx RSX K Series

- H421524 1.88" Round
- H421525 2.00" Round
- H421543 1.75" Oval
- H421544 1.88" Oval
- H421545 2.00" Oval



H4220xx S-2000 F Series

- H422024 1.88" Round
- H422025 2.00" Round
- H422043 1.75" Oval
- H422044 1.88" Oval
- H422045 2.00" Oval

◆ Ask about our face relieved lightened versions

Sport Compact

Mitsubishi



MIT4264xx 4 cyl. 16V DOHC
(4G63 - 4G61 - 4G67- 4G93 - 4G94)

MIT426444 1.88" Oval
MIT426445 2.00" Oval
MIT426446 2.13" Oval



MIT6263xx 3.0L V6 24V DOHC
(6G72 - 6A12 - 6A12TT- 6A13)

MIT626343 1.63" Oval
MIT626344 1.75" Oval
MIT626345 1.88" Oval

Nissan

Coming Soon

N62824x 3.0-3.5L V6. 24V
(VQ30DE - VQ35DE)

Coming Soon

N42815x 2.4L 4 cyl. 12V SOHC
(KA24DE / E)



N4280xx 2.0L 4 cyl. 16V DOHC
(SR20DE / DET / VE / VET)

N428042 1.63" Oval
N428043 1.75" Oval
N428044 1.88" Oval

Subaru

Coming Soon

Toyota



T6245xx 3VZE 3.0L V6

T624552 1.63" Oval
T624553 1.75" Oval



T4241xx 2TC/3TC

T424111 1.50" Rectangle
T424112 1.63" Rectangle
T424113 1.75" Rectangle



T8240xx Tundra/Lexus V8



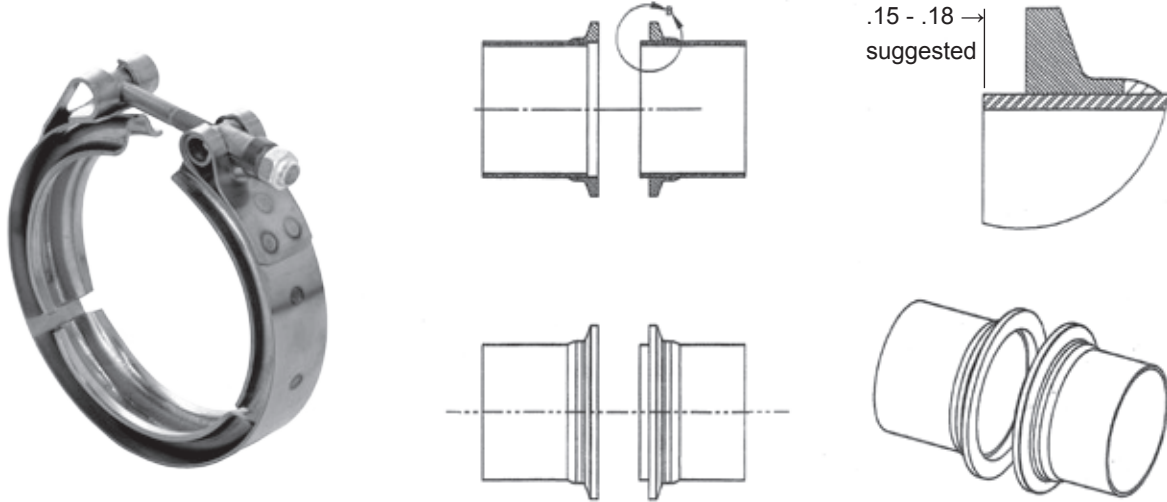

T824023 1.75" Round
T824024 1.88" Round
T824025 2.00" Round

V-Band Clamps



V-Band Clamps have been around for ages. Most notably called “Marmon Clamps & Flanges”, they are used in a variety of commercial and industrial applications, including turbo exhaust. In recent years their popularity has grown. The high tech form and function of our universal V-band clamps and sealing flanges has made them irresistible to racers and customizers.

SPD Sealing Flanges are CNC machined from billet 1020 carbon steel or 304 stainless. The close tolerances, high quality material, and male / female set-up engagement (as shown above), provides a gasketless seal.

Tube Size OD	V-Band Kit	V-Band Clamp	Sealing Flange	V-Band Assembly
2.00"	VBK200	VBC200	SF200	VBA200
2.25"	VBK225	VBC225	SF225	VBA225
2.50"	VBK250	VBC250	SF250	VBA250
3.00"	VBK300	VBC300	SF300	VBA300
3.50"	VBK350	VBC350	SF350	VBA350
4.00"	VBK400	VBC400	SF400	VBA400
4.50"	VBK450	VBC450	SF450	VBA450
5.00"	VBK500	VBC500	SF500	VBA500
				
Includes	(1) Clamp (2) Sealing Flanges	(1) Clamp	(1) Sealing Flange	(1) Clamp (2) Sealing Flanges (2) 3" Stub Tubes (2) Weld Fees

Add a “S” for 304 stainless steel example: (VBK300S or SF300S)

All clamps are made stainless steel.

Standard Exhaust Flanges

Flange Part #	Use Gasket P/N	Flange ID	Bolt Center	Material Thickness
F150-2CNC	EG150-2	1.500	2.63	0.375
F163-2CNC	EG163-2	1.625	2.63	0.375
F175-2CNC	EG175-2	1.750	3.00	0.375
F188-2CNC	EG188-2	1.875	3.00	0.375
F200-2CNC	EG200-2	2.000	3.00	0.375
F213-2CNC		2.125	3.00	0.375
F225-2CNC	EG225-2	2.250	3.50	0.375
F250-2CNC	EG250-2	2.500	3.88	0.375
F300-2CNC		3.000	4.12	0.375

2 Bolt



Add a "S" for 304 stainless steel example: (F300-2SCNC)

SPD 2 bolt flanges are designed to fit the standard flange patterns used in the exhaust industry.

Flange Part #	Use Gasket P/N	Flange ID	Bolt Circle	Material Thickness
F200-3CNC	EG200-3	2.000	3.13 bc	0.375
F225-3CNC	EG225-3	2.250	3.13 bc	0.375
F250-3CNC	EG250-3	2.500	3.50 bc	0.375
F275-3CNC		2.750	3.94 bc	0.375
F300-3CNC	EG300-3	3.000	3.94 bc	0.375
F350-3CNC	EG350-3	3.500	4.46 bc	0.375

3 Bolt



Add a "S" for 304 stainless steel example: (F300-3SCNC)

SPD 3 bolt flanges are designed to fit the standard flange patterns used in the exhaust industry.

Flange Part #	Use Gasket P/N	Bolt Circle (bc)	Material Thickness
F250-3BPCNC	EG250-3	3.50 bc	0.375
F300-3BPCNC	EG300-3	3.94 bc	0.375
F350-3BPCNC	EG350-3	4.46 bc	0.375

Block Off Plate



Add a "S" for 304 stainless steel example: (F300-3SBPCNC)

SPD Block Off Plates allow one to cap the exhaust manifold / header outlets and run exhaust back under the car. Used mostly on vintage Hot Rod "cut out" or "log" style manifolds.

Specialty Flanges



3.0CSI Outlet Flange

F5222808 .500 304 SST

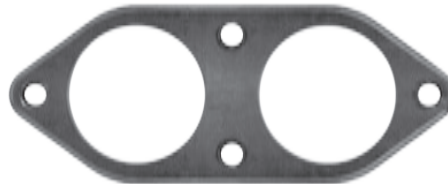

M30 Exhaust Flange

F5202507 .500 Mild Steel
F5202707 .500 304 SST

Mistubishi (Eclipse)



Catalytic Conv. Flange

F5122113 .375 304 SST



Muffler Flange

F5112113 .375 304 SST

Porsche



Fits flat opposed 4 and 6 cylinder engines

Flange Part #	Flange ID	Bolt Holes	Bolt Centers (bc)	Material Thickness
PO617121-I	1.500	2	66mm (2.599)	0.375
PO617122-I	1.625	2	66mm (2.599)	0.375
PO617123-I	1.750	2	66mm (2.599)	0.375

Add a "S" for 304 stainless steel example: (PO617121-**S**)

VW



Fits most air cooled Volkswagon flat opposed 4 cylinder engines

Flange Part #	Flange ID	Bolt Holes	Bolt Centers (bc)	Material Thickness
F125-2CNC-VW	1.250	2	58mm 2.283)	0.375
F138-2CNC-VW	1.375	2	58mm (2.283)	0.375
F150-2CNC-VW	1.500	2	58mm (2.283)	0.375
F163-2CNC-VW	1.625	2	58mm (2.283)	0.375

Add a "S" for 304 stainless steel example: (F125-2**S**CNC-VW)

Ducati



999 Vista DA/B
2.00" Tube
F5344305 .250 304 SST

Harley Davidson



Weld-on (not compression style)
F5302304 .375 304 SST

More to come.....

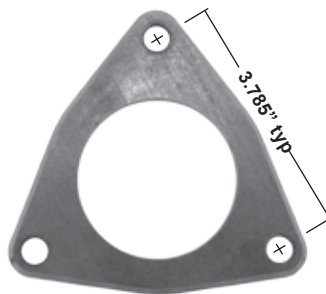

Gen III Truck (Pass. Side)

F5172109 .375 Mild Steel
 F5172609 .500 Mild Steel
 F5172309 .375 304 SST
 F5172809 .500 304 SST

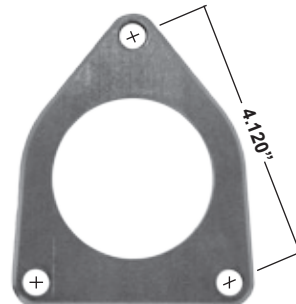

Gen III Truck (Dr. Side)

F5162109 .375 Mild steel
 F5162609 .500 Mild steel
 F5162309 .375 304 SST
 F5162809 .500 304 SST



98-02 LS-1 Camaro (Driver Side)

F5252110 .375 Mild Steel
 F5252310 .375 304 SST



**95-02 LT-1 LS-1 Camaro (Pass. Side)
 94-96 Caprice**

F5262109 .375 Mild Steel
 F5262309 .375 304 SST



92-04 Corvette
 (Includes LT-1 / LT-4 & LS-1 / LS-6)

F5152109 .375 Mild Steel
 F5152309 .375 304 SST

Side Pipes

Flange Part #	Flange ID	Bolt Holes	Bolt Centers (bc)	Material Thickness
F5016114	1.875	8	58mm(2.283)	0.375
F5016115	2.000	8	58mm(2.283)	0.375
F5016116	2.125	8	58mm(2.283)	0.375
304 Stainless Steel				
F5018114	1.875	8	58mm(2.283)	0.375
F5018115	2.000	8	58mm(2.283)	0.375
F5018116	2.125	8	58mm(2.283)	0.375

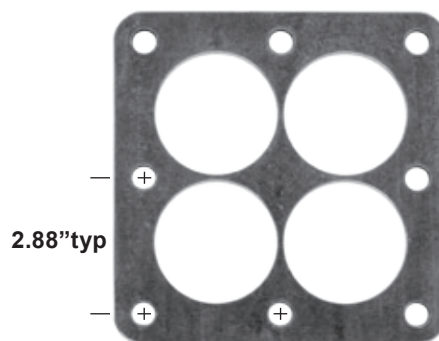

Typically used on Cobras to join side pipes to the header tubes just inside the fender well.

Ford GT

Manifold Flange

F5052811 .500 304 SST
 F5052811 .500 MS

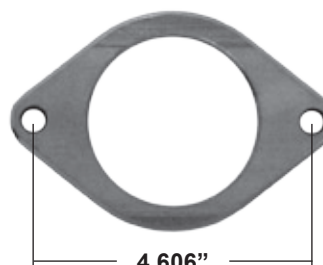

Catalytic Conv. Flange

F5062113 .375 MildSteel
 F5062613 .500 MildSteel
 F5062313 .375 304 SST
 F5062813 .500 304 SST

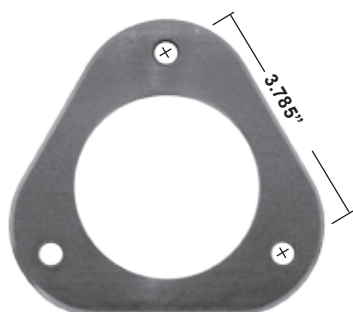

See page 29 for header flanges

(TF) Turbo Inlet Flanges

T25

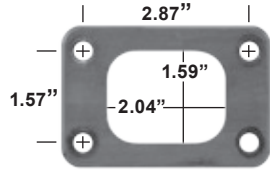

T25-T28 Rectangle

TF251005 .375 Mild Steel
TF251205 .375 304 SST

◆ Flanges available with tapped bolt holes

T03

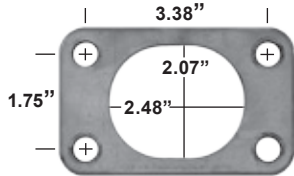

2.25" Oval

TF034607 .500 Mild Steel
TF034807 .500 304 SST

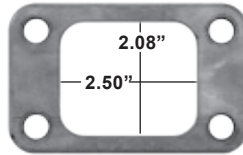

2.50" Rectangle

TF031110 .500 Mild Steel
TF031310 .500 304 SST



1.625" x (2) Tangential

TF331102 .500 Mild Steel
TF331302 .500 304 SST

◆ Flanges available with tapped bolt holes

T04

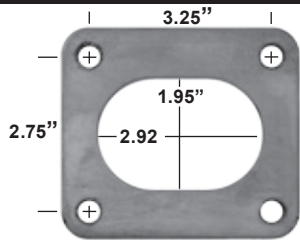

2.50" Oval

TF044609 .500 Mild Steel
TF044809 .500 304 SST

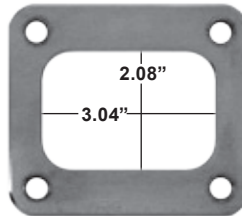

3.00" Rectangle

TF041113 .500 Mild Steel
TF041313 .500 304 SST



3.00" Lightened

TF041613 .500 Mild Steel
TF041813 .500 304 SST

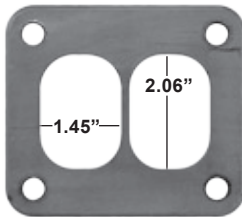

1.875" x (2) Tangential

TF441104 .500 Mild Steel
TF441304 .500 304 SST

◆ Flanges available with tapped bolt holes

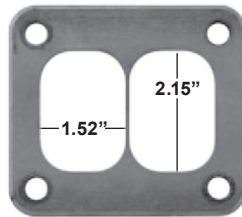

2.00" x (2) Tangential

TF441105 .500 Mild Steel
TF441305 .500 304 SST

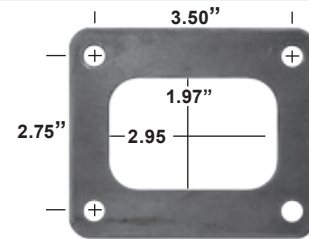

T04E (Wide Bolt Pattern)

TF071614 .500 Mild Steel
TF071814 .500 304 SST

T 100 (Large Frame)

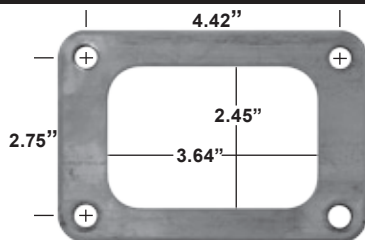

Rectangle

TF101120 .500 Mild Steel
TF101320 .500 304 SST



Lightened

TF101620 .500 Mild Steel
TF101820 .500 304 SST

◆ Flanges available with tapped bolt holes

Turbo Flanges (TF)

Turbo Outlets



HKS 100mm

Tube Size	1018 Mild Steel	304 Stainless
2.75"	TF272111	TF272311
3.00"	TF272113	TF272313

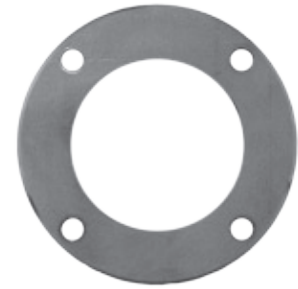

T04

Tube Size	1018 Mild Steel	304 Stainless
2.75"	TF242011	TF242211
3.00"	TF242013	TF242213

Wastegates

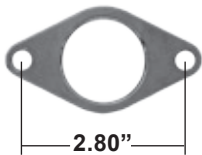

Counterbored for 1.50" O.D.tube

Deltagate

TF122601	.375 Mild Steel
TF122701	.375 Mild Steel (Tapped 5/16-18)
TF122801	.375 304 SST
TF122901	.375 304 SST (Tapped 5/16-18)

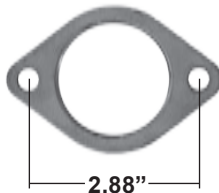

Counterbored for 1.75" O.D.tube

Racegate

TF152603	.375 Mild Steel
TF152703	.375 Mild Steel (Tapped 3/8-16)
TF152803	.375 304 SST
TF152903	.375 304 SST (Tapped 3/8-16)

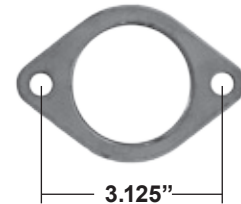

Counterbored for 2.125" O.D.tube

Indygate

TF182606	.375 Mild Steel
TF182806	.375 304 SST

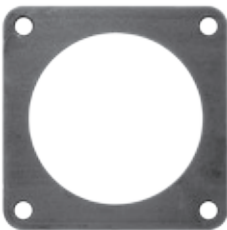

3.00" ID Sandwich Flange

TF062613	.500 Mild Steel (Tapped 3/8-16)
TF062813	.500 304 SST (Tapped 3/8-16)



HKS Standard 40mm

TF262001	.375 Mild Steel
TF262201	.375 304 SST

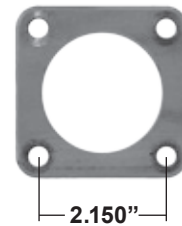

Greddy 47 mm

TF222005	.375 Mild Steel
TF222205	.375 304 SST

(ARP) Header Bolts



Thread Size & Pitch	Head	UHL	ARP Black Oxide	ARP SST 300 Series	Pkg Qty	
3/8-16	3/8 Hex	.750"	ARP100-1101	ARP400-1101	12 pcs.	
		.750"	ARP100-1102	ARP400-1102	16 pcs.	
	3/8 Hex (Drilled)	1.00"			ARP334-2102	12 pcs.
		.750"		ARP100-1103	ARP400-1103	12 pcs.
		.875"			ARP400-1104	16 pcs.
		.750"			ARP400-1105	16 pcs.
		.875"			ARP400-1106	12 pcs.
	5/16 Hex		.750"	ARP100-1107	ARP400-1107	12 pcs.
			.750"	ARP100-1108	ARP400-1108	16 pcs.
			1.00"	ARP100-1109	ARP400-1109	12 pcs.
			1.00"	ARP100-1110	ARP400-1110	16 pcs.
	3/8 12pt.		.750"	ARP100-1201	ARP400-1201	12 pcs.
			.750"	ARP100-1202	ARP400-1202	16 pcs.
			.750"	ARP100-1203	ARP400-1203	12 pcs.
	3/8 12pt. (Drilled)		.875"		ARP400-1204	16 pcs.
			.750"		ARP400-1205	16 pcs.
			.875"		ARP400-1206	12 pcs.
	5/16 12pt.		.750"	ARP100-1207	ARP400-1207	12 pcs.
			.750"	ARP100-1208	ARP400-1208	16 pcs.
			.750"	ARP100-1209	ARP400-1209	12 pcs.
1.00"			ARP100-1210	ARP400-1210	16 pcs.	
5/16-18	3/8 Hex	.750"	ARP144-1102	ARP444-1102	14 pcs.	
	3/8 12pt.	.750"	ARP144-1202	ARP444-1202	14 pcs.	
LS-1 Stud Kit	8mm. 12pt.	1.250"		ARP434-1301	12 pcs.	

O2 - NPT - Vac-u-pan - A.I.R. - EGT

	Part #	Thread & Pitch	Description
O2	O2-1815	18mm x 1.5	O-2 Weld-on 18 mm x 1.50 pitch
	O2-1815S	18mm x 1.5	O-2 Weld-on 304 SST 18mm x 1.50 pitch
	O2-1815P	18mm x 1.5	O-2 Plug 18 mm x 1.50 pitch
	O2-1815G	18mm x 1.5	O-2 Gasket 18 mm (copper)



	Part #	Thread & Pitch	Description
NPT Bungs	NPT125	1/8" NPT	Female 1/8" NPT Bung
	NPT125S	1/8" NPT	Female 1/8" NPT Bung 304 SST
	NPT250	1/4" NPT	Female 1/4" NPT Bung
	NPT250S	1/4" NPT	Female 1/4" NPT Bung 304 SST
	NPT375	3/8" NPT	Female 3/8" NPT Bung
	NPT375S	3/8" NPT	Female 3/8" NPT Bung 304 SST
	NPT500	1/2" NPT	Female 1/2" NPT Bung
	NPT500S	1/2" NPT	Female 1/2" NPT Bung 304 SST
NPT Plugs	NPT125SP	1/8" NPT	Female 1/8" NPT Plug 304 SST
	NPT250SP	1/4" NPT	Female 1/4" NPT Plug 304 SST
NPT Nipples	NPT500-M	1/2" NPT	Male 1/2" NPTx 6.00" oal coupler (for Vac-u-pan)
	NPT500-MS	1/2" NPT	Male 1/2" NPTx 6.00" oal 304 SST Coupler (for Vac-u-pan)



	Part #	Thread & Pitch	Description
A.I.R.	GM1/2-18	1/2" - 18	Female fitting to accept OEM GM A.I.R. manifold



	Part #	Thread & Pitch	Description
E.G.T.	TF0125	1/8" NPT	Male 1/8" Compression Fitting
	TF0125S	1/8" NPT	Male 1/8" Compression Fitting 304 SST
	For use with Racepak E.G.T. Probes		
	TF0250	1/4" NPT	Male 1/4" Compression Fitting
	TF0250S	1/4" NPT	Male 1/4" Compression Fitting 304 SST



T-Bolt Clamps



Part #	Tube Size ID	Size Range
TBC125	1.250	1.16 - 1.47
TBC150	1.375 - 1.500	1.25 - 1.56
TBC163/175	1.625 - 1.750	1.55 - 1.83
TBC188	1.750 - 1.875	1.73 - 2.03
TBC200	2.000	1.86 - 2.17
TBC213	2.125	2.03 - 2.34
TBC225	2.250	2.16 - 2.47
TBC238	2.375	2.20 - 2.51
TBC250	2.500	2.34 - 2.65
TBC263	2.625	2.41 - 2.72
TBC275	2.750	2.66 - 2.97
TBC300	3.000	2.91 - 3.22
TBC325	3.250	3.16 - 3.47
TBC350	3.500	3.41 - 3.72
TBC375	3.750	3.66 - 3.97
TBC400	4.000	3.78 - 4.09
TBC413	4.125	4.03 - 4.35
TBC500	5.000	4.78 - 5.09
TBC 600	6.000	5.78 - 6.09

T-Shirts

Med - Large - XL - 2X \$15.00

Available in:
White or Ash



Part #	Description
For use in welding 304 stainless	
30803536	308 x .035 x 36" oal Stainless Tig Welding Wire
30804536	308 x .045 x 36" oal Stainless Tig Welding Wire
30806236	308 x .062 x 36" oal Stainless Tig Welding Wire
For use in welding 304 stainless to carbon steel	
30903536	309 x .035 x 36" oal Stainless Tig Welding Wire
30904536	309 x .045 x 36" oal Stainless Tig Welding Wire
30906236	309 x .062 x 36" oal Stainless Tig Welding Wire
For use in welding 321 or 304 Stainless	
34703536	347 x .035 x 36" oal Stainless Tig Welding Wire
34704536	347 x .045 x 36" oal Stainless Tig Welding Wire
34706236	347 x .062 x 36" oal Stainless Tig Welding Wire
Solarflux B	Flux for welding stainless & alloy steels Used in place of an inert purge inside of parts being welded.
For TIG welding mild steel	
70S203536	70S-2 mild steel TIG welding rod
70S204536	70S-2 mild steel TIG welding rod
70S206236	70S-2 mild steel TIG welding rod
For TIG brazing stainless or mild steel	
SIB03536	Silicone Bronze TIG brazing rod
SIB06236	Silicone Bronze TIG brazing rod

Part #	Description
CW14MA	14" x 7/64" x 1" metal cut-off wheel
CW14MASR	14" x 7/64" x 1" metal cut-off wheel (stainless)

HR10040	Handy roll 40-grit (1" x 50+yds)
---------	----------------------------------

PSA16	16" cloth PSA disc - 36 grit
-------	------------------------------

AFD40	Abrasive flap disc - 40 grit x 4.50 OD
-------	--

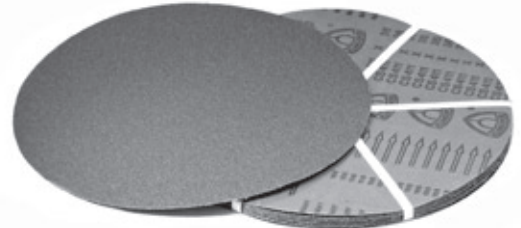

SPD currently manufactures private label components and finished products for a number of companies in the automotive industry. We can work from an existing design or create a prototype for you. Our years of experience in research and development on exhaust products, for the racing industry, are at your disposal to ensure the best results for your finished product.

Header Sets

We will gladly quote on special headers with a quantity of 25 sets or greater. As with all of our products, we use the best materials available in the manufacturing process. From prototype to finished product, SPD can help with every step.

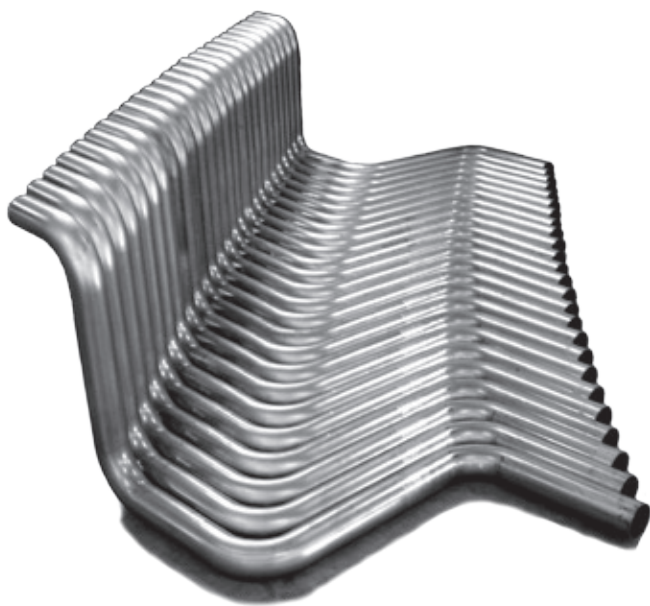

Custom Bends & Tube Bending

Our NC and CNC mandrel benders are capable of bending up to 3.5" in most materials. We also have an extensive and growing list of tooling to provide you with the right radius for your project (see mandrel bend table pgs.20-21). To make parts more cost effective and reduce or eliminate set-up time costs, we have a 50 piece minimum per tube size and center line radius.



CNC Machining

With our Mazak VTC200-50 CNC machining center, we produce machined header flanges that meet exacting standards. We stock well over 100 different applications for OEM and aftermarket cylinder heads. Most come in a variety of port shapes and sizes and are available from $\frac{3}{8}$ " thick 1018 cold rolled steel.

If you don't see your application in our catalog, it is possible we can machine them for you. The popularity of some applications may make ideal additions to our product line. In this case, any special programming and set-up fees can be reduced or eliminated.

$\frac{1}{2}$ " thick and/or 304 stainless are available by special order.

Component Fabrication



With your technical drawings or simple specifications (depending on the complexity of your part) we can fabricate your custom parts. Parts costs are figured at time and materials. Some parts may require fixtures.

Custom Exhaust

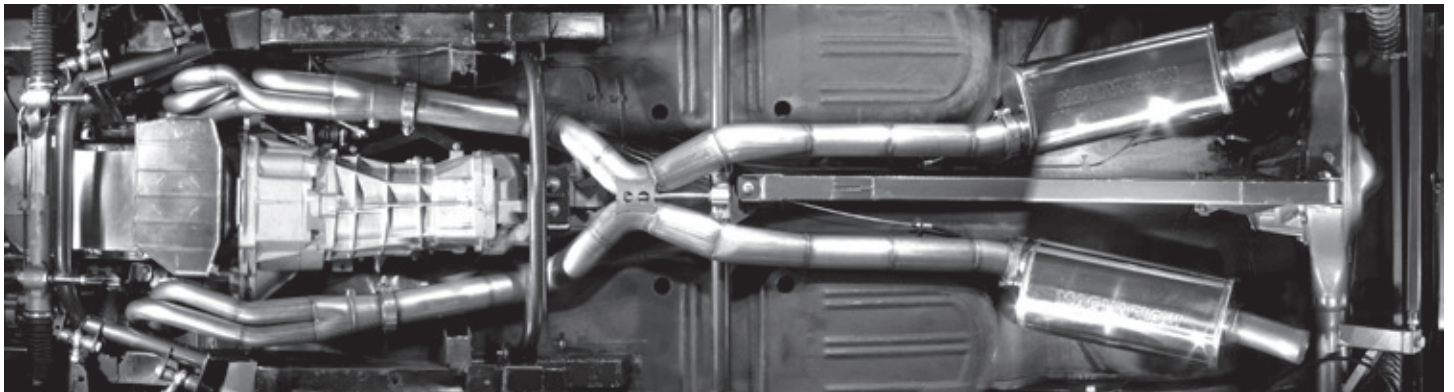

The primary focus at SPD continues to be supplying fabricators and distributors with quality components. We do still regularly put those parts to use building custom headers and exhaust systems. If you are within towing distance, say 2 - 2000 miles, please call and talk to us about bringing your race car, boat, motorcycle, or street rod in for some new pipes.

Racing Headers

SPD produces headers for a number of racing classes with standard engine / chassis configurations.

Stock Cars

Late models (ASA) / Cup / NCTS

Drag Racing

Top Fuel / Top Alcohol / Funny Car

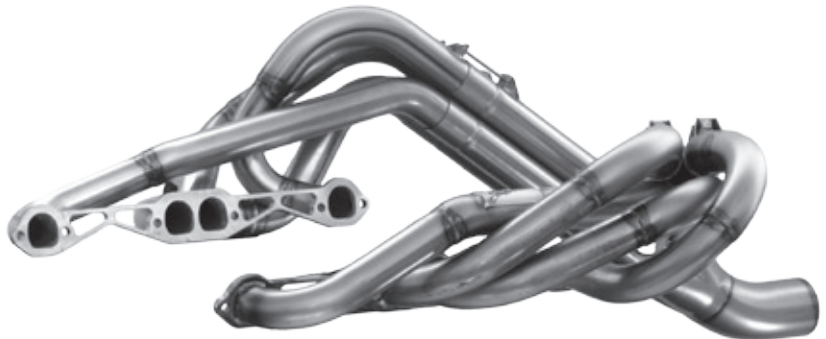

Vehicle Specification Form



Name _____

Cust # _____

Company _____

Phone # _____

Fax # _____

Chassis

Car _____

Style _____

Weight _____

Sanctioning Body

Class _____

Track _____

Engine

Mfg. _____

Type _____

C.I.D. _____

Intake

Type _____

Runner Length _____

Carb. _____

Heads

Model _____

Intake CFM _____

Exhaust CFM _____

Cam

Intake Lift _____

Exhaust Lift _____

Lobe Center _____

Intake Dur. _____

Exhaust Dur. _____

Dyno

Peak HP _____

@ _____ RPM

Peak Torque _____

@ _____ RPM

RPM Range

Low _____

High _____

Transmission

Type _____

1st Gear _____

Stall _____

Tire / Gear

Tire Size _____

Gear Ratio _____



SPD's Promise

SPD has built and maintained a reputation for quality and service. Part of that service is making our comprehensive product line available to ship the same day. We know your business or race team race team depends on fast service. The size and structure of our company allows us to be nimble enough to provide you with off the shelf or custom parts in a timely manner.

Order Processing In Stock

*On orders placed before 2:30pm PST
Every effort will be made to ship the same day.*

*Processing of orders placed after 2:30pm PST
Will vary depending on the order volume of the day.*

Back Orders

Back orders will be expedited and shipped as soon as time and materials allow.

Shipping

FedEx Sevices Available

Overnight

Standard Overnight

by 3:00pm

Priority Overnight

by 10:30am (Noon if C.O.D.)

First Overnight

by 8:30am

Saturday Delivery

2-Day

2nd Day

by 4:30pm

3-Day

Express Saver

by 4:30pm

FedEx Freight

350 lbs. min. on out of state shipments

Returns

Call for a RGA (Return Goods Authorization) on any returns.

No products may be returned for credit after 30 days from receipt of merchandise.

(Please check inspect shipments immediately upon receipt)

All returns are subject to a 25% restocking fee (unless shipped in error)

No returns on Merge Collectors, straight tubing, or custom / special order parts

Making a pencil transfer (Rubbing)

Due to the rapidly changing cylinder head industry, you may be asked to send a rubbing of your exhaust ports.



Place a sheet of paper covering port(s). Holding it firmly with one hand, use your index finger to rub the edges of the port(s) and bolt holes.



Holding the pencil's face flat against the paper, define the ports and bolt pattern.

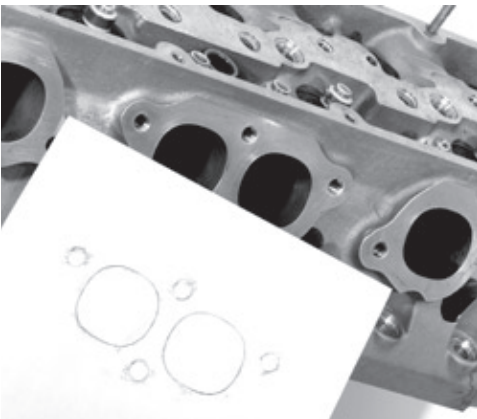

Make sure the transfer is accurate and the paper did not slip during the process.

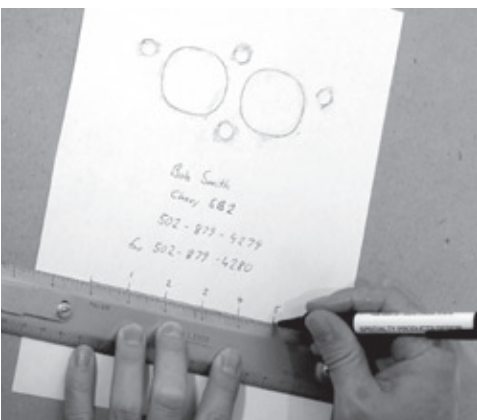

Please include a scale along with your contact information as the fax machine will shrink the image.